

TWS LED



TWS LED

Modulo / Module / Élément Ghiera / Ring / Bague



TWS LED MULTI

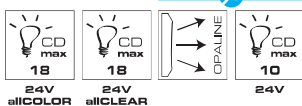

TWS LED STEADY

V DC	24	-	-	-
V AC	-	24	110	240
mA	65	85	35	35

TWS LED MULTI

V DC	24	-	-	-	-	-	-	-	-	-	-	-	-	-	-	-	-	-	-	
V AC	-	-	24	-	-	-	110	-	-	-	-	-	-	-	-	-	-	-	-	240
Flash	-	1F	2F	3F	-	1F	2F	3F	-	1F	2F	3F	-	1F	2F	3F	-	1F	2F	3F
mA	65	40	30	35	85	60	50	35	25	20	25	35	25	20	25	35	25	20	25	35

Codici / Codes

TWS LED

Riferimenti pagina 158, paragrafo "TWS LED"
See page 158, section "TWS LED"
Voir page 158, section "TWS LED"

Modulo luminoso a LED integrato. **TWS LED** offre una manutenzione teoricamente nulla grazie alla tecnologia a LED che garantisce 100.000* ore d'utilizzo. Disponibile in versione **STEADY** (luce fissa) o **MULTI** (luce fissa, singolo, doppio e triplo lampeggio) con lente **allCOLOR**, **allCLEAR** o **PROXIMITY**.

* In condizioni normali, in assenza di vibrazioni e sbalzi di temperatura

Tensione operativa

24V ACDC, 110V AC, 240V AC +/-10%

Caratteristiche meccaniche

Polycarbonato autoestinguente ad alta resistenza agli impatti, adatto per utilizzo esterno grazie al grado di protezione IP66, UL TYPE 4X, garantito dalla doppia guarnizione in poliuretano presente su ogni modulo.

Caratteristiche luminose

Lente con rigatura verticale per una perfetta distribuzione della luce a 360°.

TWS LED STEADY: luce fissa

TWS LED MULTI: luce fissa, singolo lampeggio 1F, doppio lampeggio 2F, triplo lampeggio 3F selezionabili tramite dip-switch.

Disponibili con 3 tipi di lente: **allCOLOR** (lente colorata con fonte luminosa colorata), **allCLEAR** (lente neutra con fonte luminosa colorata) e **PROXIMITY** (lente colorata opalina con fonte luminosa colorata), vedi pagina 132.

Certificazioni / Certifications

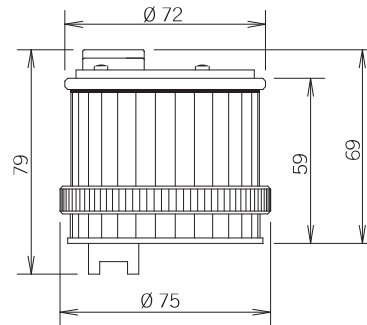

TWS LED



Integrated LED light module. **TWS LED** offers virtually zero maintenance thanks to the built-in LED technology that guarantees up to 100.000* hours of product life.

Available in **STEADY** (steady light) and **MULTI** (steady light, single, double and triple flash) version, with **allCOLOR**, **allCLEAR** and **PROXIMITY** lens.

* At normal conditions, without vibrations and heavy temperature changes

Voltages

24V ACDC, 110V AC, 240V AC +/-10%

Mechanical features

Self-extinguishing PC body with high impact resistance, suitable for outdoor use thanks to the IP66, UL TYPE 4X protection grade, guaranteed by a double polyurethane gasket on each module.

Optical features

The vertically lined lens allows a perfect light distribution over 360°.

TWS LED STEADY: steady light

TWS LED MULTI: steady light, 1F single, 2F double and 3F triple flash selectable via dip-switch.

Available with 3 different lens types, **allCOLOR** (colored lens with colored light source), **allCLEAR** (clear lens with colored light source) and **PROXIMITY** (opaline colored lens with colored light source), see page 132.



Élément lumineux à LED intégrée. **TWS LED** offre un entretien quasi-nul grâce à la technologie intégrée du LED qui garantit jusqu'à 100.000* heures de vie au produit.

Disponible en version **STEADY** (lumière fixe) et **MULTI** (lumière fixe, simple, double ou triple éclat) avec lentille **allCOLOR**, **allCLEAR** ou **PROXIMITY**.

* Dans des conditions normales, sans vibrations et sans variations importantes de température

Tension d'utilisation

24V ACDC, 110V AC, 240V AC +/-10%

Caractéristiques mécaniques

Polycarbonate autoextinguible, haute résistance aux chocs, adapté pour une utilisation à l'extérieur grâce au degré de protection IP66, UL TYPE 4X, garanti par un double joint en polyuréthane sur chaque élément.

Caractéristiques optiques

La lentille striée en verticale permet une répartition parfaite de la lumière sur 360°.

TWS LED STEADY: lumière fixe

TWS LED MULTI: lumière fixe, simple éclat 1F, double éclat 2F ou triple éclat 3F sélectionnables par dip-switch.

Disponible avec 3 différents types de lentilles: **allCOLOR** (lentille colorée et source lumineuse colorée), **allCLEAR** (lentille incolore transparente avec source lumineuse colorée) et **PROXIMITY** (lentille opaline colorée avec source lumineuse colorée), voir page 132.

Codici / Codes

BASE / BASE / BASE









27700 27690

TWS LED

Modulo a LED integrato / Integrated LED light module / Élément lumineux à LED intégrée

STEADY (luce fissa / steady light / lumière fixe)







						
aICOLOR 24V ACDC	36471 36681	36472 36682	36473 36683	36474 36684	36475 36685	36476 36686
110V AC	36481 36691	36482 36692	36483 36693	36484 36694	36485 36695	36486 36696
240V AC	36491 36701	36492 36702	36493 36703	36494 36704	36495 36705	36496 36706
aICLEAR 24V ACDC	33121 33151	33122 33152	33123 33153	33124 33154	33122 33152	36476 36686
110V AC	33131 33161	33132 33162	33133 33163	33134 33164	33132 33162	36486 36696
240V AC	33141 33171	33142 33172	33143 33173	33144 33174	33142 33172	36496 36706
PROXIMITY 24V ACDC	32201 32231	32202 32232	32203 32233	32204 32234	32205 32235	32206 32236
110V AC	32211 32241	32212 32242	32213 32243	32214 32244	32215 32245	32216 32246
240V AC	32221 32251	32222 32252	32223 32253	32224 32254	32225 32255	32226 32256

MULTI (luce fissa, lampeggio singolo, doppio o triplo / steady light, single, double or triple flash / lumière fixe, flash simple, double ou triple éclat)

						
aICOLOR 24V ACDC	36501 36711	36502 36712	36503 36713	36504 36714	36505 36715	36506 36716
110V AC	36511 36721	36512 36722	36513 36723	36514 36724	36515 36725	36516 36726
240V AC	36521 36731	36522 36732	36523 36733	36524 36734	36525 36735	36526 36736
aICLEAR 24V ACDC	33181 33211	33182 33212	33183 33213	33184 33214	33182 33212	36506 36716
110V AC	33191 33221	33192 33222	33193 33223	33194 33224	33192 33222	36516 36726
240V AC	33201 33231	33202 33232	33203 33233	33204 33234	33202 33232	36526 36736
PROXIMITY 24V ACDC	32261 32291	32262 32292	32263 32293	32264 32294	32265 32295	32266 32296
110V AC	32271 32301	32272 32302	32273 32303	32274 32304	32275 32305	32276 32306
240V AC	32281 32311	32282 32312	32283 32313	32284 32314	32285 32315	32286 32316

TWS S

Modulo a LED integrato superluminoso multifunzione / Superbright multifunctional integrated LED light module / Élément extra lumineux à LED intégrée multifonctionnel

						
12/24V ACDC aICOLOR	33411 33421	33412 33422	33413 33423	33414 33424	33415 33425	33416 33426
12/24V ACDC aICLEAR	33431 33441	33432 33442	33433 33443	33434 33444	33435 33445	33416 33426

TWS RGA

Modulo a LED integrato superluminoso multicolore / Superbright multicolor integrated light module / Élément extra lumineux multicolore à LED intégrée

	
12/24V ACDC	33447 33448

TWS STEADY/FLASHING*

Modulo tradizionale con attacco BA15d / Light module with traditional BA15d lamp holder / Élément lumineux avec douille BA15d

STEADY (luce fissa / steady light / lumière fixe)

						
12/240V ACDC	27701 27631	27702 27632	27703 27633	27704 27634	27705 27635	27706 27636

* Fornito senza lampada / Supplied without bulb / Fourni sans ampoule

FLASHING (luce lampeggiante / flashing light / lumière clignotante)

						
12/48V DC	27711 27641	27712 27642	27713 27643	27714 27644	27715 27645	27716 27646
24/240V AC	27721 27651	27722 27652	27723 27653	27724 27654	27725 27655	27726 27656

* Fornito senza lampada / Supplied without bulb / Fourni sans ampoule