

# babyTWS

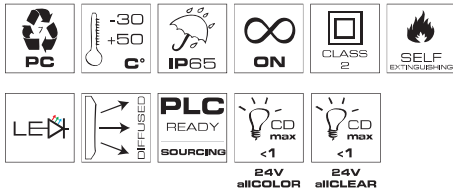

allCLEAR  
babyTWS

Modulo / Module / Élément



babyTWS		babyTWS SOUNDER	
V ACDC	24	V ACDC	24
mA	50	mA	10
		dB(A)1m	72

Base cablaggio  
Wiring base  
Base de câblage

Modulo acustico  
Sounder module  
Élément acoustique



Modulo / Module / Élément



Modulo / Module / Élément

Codici / Codes

**babyTWS**

Riferimenti pagina 164, paragrafo "babyTWS"  
See page 164, section "babyTWS"  
Voir page 164, section "babyTWS"

**MODULO LUMINOSO**

Modulo luminoso a LED integrato con funzione STEADY (luce fissa). babyTWS offre una manutenzione teoricamente nulla grazie alla tecnologia a LED che garantisce 100.000\* ore d'utilizzo. Disponibile con lenti allCOLOR o allCLEAR.

\* In condizioni normali, in assenza di vibrazioni e sbalzi di temperatura

**Tensione operativa**

24V ACDC +/-10%

**Caratteristiche meccaniche**

Polycarbonato autoestinguente con grado di protezione IP65, UL TYPE 3R.

**Caratteristiche luminose**

Lente con rigatura verticale per una perfetta distribuzione della luce fissa a 360°. Disponibile con 2 tipi di lente: allCOLOR (lente colorata con fonte luminosa colorata) e allCLEAR (lente neutra con fonte luminosa colorata), vedi pagina 132.

**MODULO ACUSTICO**

Modulo acustico piezoelettrico con suono intermittente, frequenza 4000 +/- 300Hz.

**BASE DI CABLAGGIO**

Base indispensabile per il cablaggio della colonna luminosa babyTWS. Dispone di un contatto comune + 6 contatti indipendenti per consentire l'assemblaggio di un massimo di 6 moduli luminosi o 5 moduli luminosi + 1 modulo acustico.

Fornita con cappello per la chiusura superiore della colonna, nel caso non sia impiegato il modulo acustico.

**Certificazioni / Certifications**

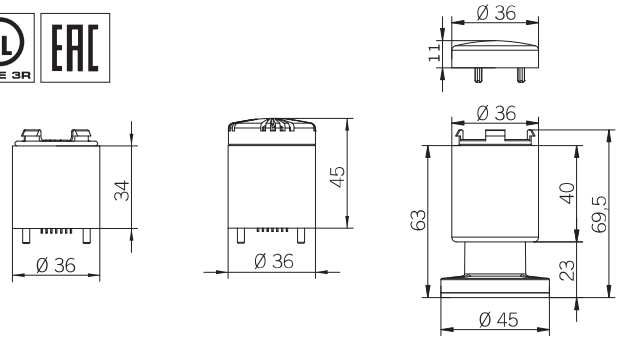

**MODULO LUMINOSO  
LIGHT MODULE  
ELEMENT LUMINEUX**



**MODULO ACUSTICO  
SOUNDER MODULE  
ELEMENT ACOUSTIQUE**



**BASE CABLAGGIO  
WIRING BASE  
BASE DE CÂBLAGE**



**LIGHT MODULE**

Integrated LED STEADY light module. babyTWS offers virtually zero maintenance thanks to the built-in LED technology that guarantees up to 100.000\* hours of product life.

Available with allCOLOR and allCLEAR lens. \* At normal conditions, without vibrations and heavy temperature changes

**Voltagés**  
24V ACDC +/-10%

**Mechanical features**  
Self-extinguishing PC body with IP65, UL TYPE 3R protection grade.

**Optical features**  
The vertically lined lens allows a perfect steady light distribution over 360°. Available with 2 different lens types, allCOLOR (colored lens with colored light source) and allCLEAR (clear lens with colored light source), see page 132.

**SOUNDER MODULE**  
Piezoelectric module with intermittent sound, frequencies 4000 +/- 300Hz.

**WIRING BASE**  
Wiring base necessary for babyTWS stacklight installation. It offers one common + 6 independent contacts and allows assembly of maximum 6 light modules or 5 light modules + 1 acoustic module. Provided with top cap to be used when the acoustic module is not installed.



**ELEMENT LUMINEUX**

Élément lumineux à LED intégrée à lumière fixe (STEADY). babyTWS offre un entretien quasiment nul grâce à la technologie intégrée du LED qui garantit jusqu'à 100.000\* heures de vie au produit.

Disponible avec lentille allCOLOR ou allCLEAR. \* Dans des conditions normales, sans vibrations et sans variations importantes de température

**Tension d'utilisation**

24V ACDC +/-10%

**Caractéristiques mécaniques**  
Polycarbonate autoextinguible, degré de protection IP65, UL TYPE 3R.

**Caractéristiques optiques**  
La lentille striée en verticale permet une répartition parfaite de la lumière fixe sur 360°. Disponible avec 2 différents types de lentilles : allCOLOR (lentille colorée et source lumineuse colorée) ou allCLEAR (lentille incolore transparente avec source lumineuse colorée), voir page 132.







**ELEMENT ACOUSTIQUE**  
Élément piézoélectrique avec son pulsé, fréquence 4000 +/- 300Hz.

**BASE DE CÂBLAGE**  
Base de câblage pour la gamme babyTWS. La base comporte un contact commun + 6 contacts indépendants, permettant le montage maximum de 6 éléments lumineux ou 5 éléments lumineux + 1 élément acoustique. Base de câblage complète avec couvercle, à utiliser lorsque l'élément acoustique n'est pas installé.

## Codici / Codes

## miniTWS

Modulo LED luce fissa/lampeggiante / Integrated LED steady/flashing light module / Élément lumineux à LED intégrée fixe/cligotant

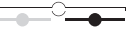
												
<b>allCOLOR</b> 24V ACDC	31501	31541	31502	31542	31503	31543	31504	31544	31505	31545	31506	31546
110V AC	31511	31551	31512	31552	31513	31553	31514	31554	31515	31555	31516	31556
240V AC	31521	31561	31522	31562	31523	31563	31524	31564	31525	31565	31526	31566
<b>allCLEAR</b> 24V ACDC	33241	33301	33242	33302	33243	33303	33244	33304	33245	33305	31506	31546
110V AC	33251	33311	33252	33312	33253	33313	33254	33314	33255	33315	31516	31556
240V AC	33261	33321	33262	33322	33263	33323	33264	33324	33265	33325	31526	31566



## babyTWS

Modulo LED luce fissa / Integrated LED steady light module / Élément lumineux fixe à LED intégrée

							
24V ACDC <b>allCOLOR</b>		36451	36452	36453	36454	36455	36456
24V ACDC <b>allCLEAR</b>		33271	33272	33273	33274	33275	36456

## ACUSTICHE / SOUNDERS / ACOUSTIQUES

miniTWS (modulo magnetodinamico / magnetodynamic module / élément magnétodynamique)

		
24V ACDC	31531	31534
110V AC	31532	31535
240V AC	31533	31536

babyTWS (modulo piezoelettrico / piezoelectric module / élément piézoélectrique)



	
24V ACDC	36461

## BASI / BASES / BASES

		
miniTWS	31500	31508
babyTWS	36450	

## ACCESSORI / ACCESSORIES / ACCESSOIRES

(miniTWS - babyTWS)

		
BP1	27762	27693
BP2	27763	27694
SB	33357	33358
BS	27760	27691
KIT	27764	27695
PR	27761	27692
M16	27777	27778
KIT SS L10	27765	27845
KIT SS L20	27766	27846
KIT SS L40	27767	27847

## LAMPADIE RICAMBIO / SPARE BULBS / AMPOULES DE RECHANGE



BA 15d

5W

scatola: box: boîte :	1x25 pz. 1x25 pcs. 1x25 pcs.	singola single individuelle	25 pz. 25 pcs. 25 pcs.
12V	70970	70941	27780
24V	70971	70942	27781
48V	70972	70943	27782
110V	70973	70944	27783
240V	70974	70945	27784

TWS STEADY/FLASHING



LD 4.5,4 WO

BA 15d

						
12V ACDC	40931	40932	40933	40934	40935	40936
24V ACDC	40941	40942	40943	40944	40945	40946
110V AC	40951	40952	40953	40954	40955	40956
240V AC	40961	40962	40963	40964	40965	40966

TWS STEADY/FLASHING



XENON

2J 71634

TWS X