

ROSETTE UP

017/..

opbouwrozet

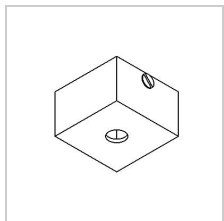
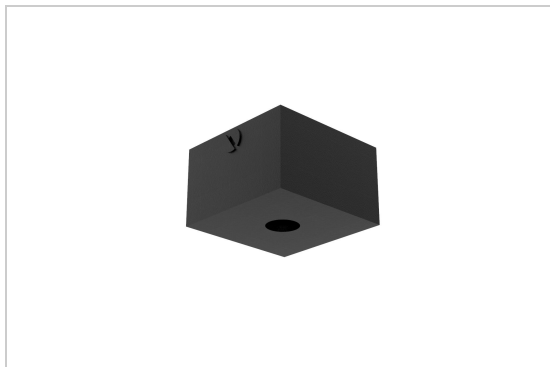

Project _____

Type _____

Nota _____

Aantal _____

Datum _____

Fysisch

Type gebruik	Interieur
Type bevestiging	Plafond
Afmetingen armatuur	40x40x25 mm
Eindtype	M10
IP-beschermingsgraad	IP20
Gewicht	0,0550 kg

Elektrisch

Armatuurklasse	III
----------------	-----

Project _____

Type _____

Nota _____

Aantal _____











Datum _____

ROSETTE UP

017/..

opbouwrozet

Kleuren

	1	wit	017.1
	11	metaalgrijs	017.11
	13	brons	017.13
	14	alu satijn	017.14
	16	goud satijn	017.16
	1M	wit textuur	017.1M
	2	zwart	017.2
	23	donker brons	017.23
	2M	zwart textuur	017.2M
	4	blinkend goud	017.4

Opties

trekontlasting _____ P040/..

trekontlasting _____ P039/..