

Cepex inbouwcontactdoos, wit - Bestelnr. 4117

- schroefklemmen
- tevens geschikt voor wandgoot en energiezuilen
- slagvast volgens DIN 18032

Technische informatie

Ampère	32 A
Polen	3 p
Voltage	230 V
Uurstand	6 h
Hertz	50-60 Hz
Beschermingsgraad	IP 44

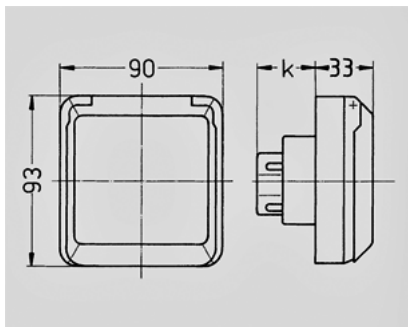

Tekening 1 MB 315	Amp. Polen	16			32		
		3	4	5	3	4	5
Maten in mm	k	32	32	32	48	48	48
Kabelaansluiting		1,5	1,5	1,5	2,5	2,5	2,5
van/tot mm ²		-4	-4	-4	-6	-6	-6