

Draaiveldtester - Bestelnr. 3527

- volgens VDE 0413, deel 7, DIN-EN 61557-7

Technische informatie

Ampere	16 A
Polen	4 p
Voltage	230 V
Uurstand	9 h
Hertz	50-60 Hz
Aansluittechniek	schroefklemmen
Contacten	standaard
Beschermingsgraad	IP 44

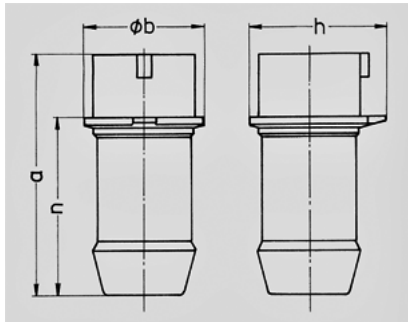

Tekening 2 MB 140	Amp.	16		32		63	
		4	5	4	5	4	5
Maten in mm	a	126	129	145	145	211	211
	b	60	65	66	74	100	100
	h	62	69	71	80	100	100
	n	90	93	99	99	145	145