

Contactstop AM-TOP® - Bestelnr. 290

- schroefklemmen
- ééndelige behuizing
- wartel met afdichting
- trekontlasting en knikbescherming

Technische informatie

Ampere	32 A
Polen	3 p
Voltage	230 V
Uurstand	6 h
Hertz	50-60 Hz
Aansluittechniek	schroefklemmen
Contacten	standaard
Beschermingsgraad	IP 67

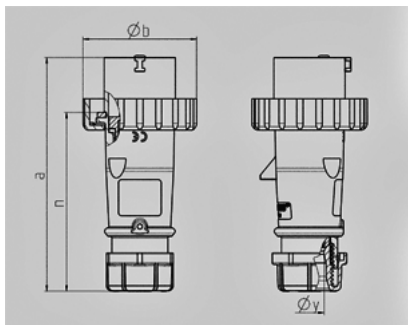

Tekening 2 MB 218	Amp. Polen	16			32		
		3	4	5	3	4	5
Maten in mm	a	142	144	147	186	186	180
	b	70	78	87	94	94	101
	n	109	111	114	145	145	138
	y	14,5	16	16	22	22	22
Kabelaansluiting		1	1	1	2,5	2,5	2,5
van/tot mm ²		—2,5	—2,5	—2,5	—6	—6	—6