

Toestelcontactstop - Bestelnr. 1955

- schroefklemmen
- met buitenliggende bevestigingen
- kabelinvoer 1 x bov en 1 x blind (breekpoort) aan de achterzijde

Technische informatie

Ampère	16 A
Polen	2 p
Voltage	20-25 V
Hertz	50-60 Hz
Uurstand	0 h
Aansluittechniek	schroefklemmen
Contacten	standaard
Beschermingsgraad	IP 44

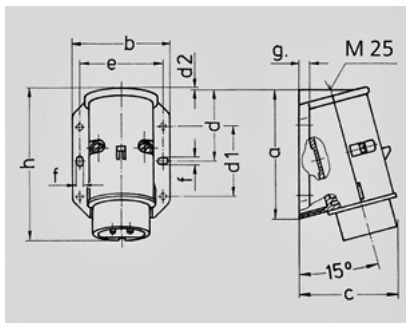

Tekening 2 MB 160	Amp. Polen	16		32	
		2	3	2	3
Maten in mm	a	96	96	96	96
	b	73	73	73	73
	c	74	74	74	74
	d	53	53	53	53
	d1	52	52	52	52
	d2	2	2	2	2
	e	62	62	62	62
	f	5,3	5,3	5,3	5,3
	g	8	8	8	8
	h	116	116	116	116
Kabelaansluiting van/tot mm ²		4	4	4	4
		-10	-10	-10	-10