

Inbouwcontactdoos TwinCONTACT - Bestelnr. 1674

- schroefloos met insteekklemmen
- geschikt voor doorlussen
- rechte uitvoering
- blinddeksel om niet gebruikte opening af te sluiten: bestelnr. 41419

Technische informatie

Ampère	16 A
Polen	4 p
Voltage	400 V
Uurstand	6 h
Hertz	50-60 Hz
Aansluittechniek	zonder schroeven, TwinCONTACT
Contacten	standaard
Beschermingsgraad	IP 44

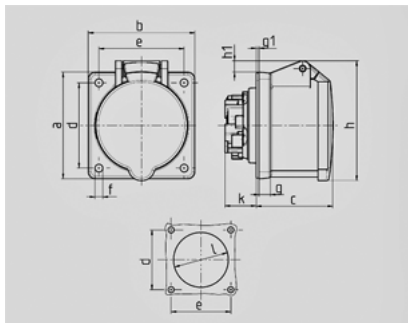

Tekening 1 MB 464	Amp. Polen	16			32		
		3	4	5	3	4	5
Maten in mm	a	75	75	75	75	75	75
	b	75	75	75	75	75	75
	c	53	53	54	64	64	64
	d	60	60	60	60	60	60
	e	60	60	60	60	60	60
	f	5,5	5,5	5,5	5,5	5,5	5,5
	g.	8	8	8	8	8	8
	g.1	2	2	2	2	2	2
	h	75	80	85	89	89	95
	h1		6	9	10	10	12
	k	22	22	22	28	28	38
l	43	52	57	60	60	65	
Kabelaansluiting van/tot mm²		1,5	1,5	1,5	2,5	2,5	2,5
		-4	-4	-4	-6	-6	-6