

# KDS®

## MURATEC-KDS CORP.

### MURATEC-KDS CORPORATION HEAD OFFICE

3, Minamiochiai-cho, Kisshoin, Minami-ku,  
Kyoto, 601-8326 JAPAN  
TEL. +81-75-681-2761 FAX. +81-75-661-2764  
E-mail : mailto:muratec-kds.jp

### CHICAGO correspondent

2026 West Cortez St.Chicago, IL60622-3630 U.S.A  
TEL. +1-773-252-1314 FAX. +1-773-252-1319  
E-mail: kevin.carter.kds@muratec-usa.com

### KDS Manufacturing (M) Sdn Bhd

Lot 7963, Batu 22, Jalan Air Hitam,  
81000 Kulai, Johor, Malaysia  
E-mail: sales@kds-ml.com.my

<http://www.muratec-kds.jp/en/>



TOTAL  
PRODUCTS  
CATALOG No.16

# KDS

MURATEC-KDS CORP.





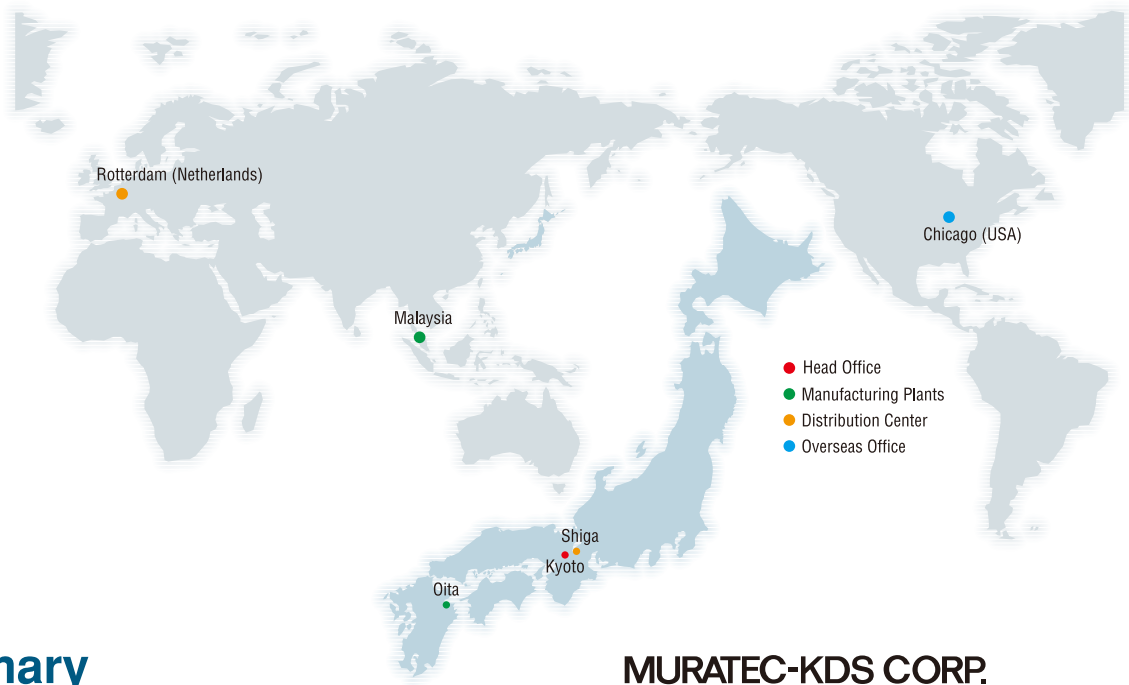

Certified  
**ISO 9001**  
**JQA-1564**  
**MURATEC-KDS CORP.**  
The design and calibration service of steel tape measures, textile tape measures.  
The design, manufacture and servicing of cutter knives, digital pole measures, weight and height digital scales.  
Servicing of builder's and surveyor's equipment.

Certified  
**ISO 9001**  
**KDS MANUFACTURING (M) SDN BHD**  
Manufacturing and assembly of measuring tape.  
Assembly of anchor line and cutter

## Summary

Company name	MURATEC-KDS CORP.
President and C.E.O	Motoyoshi Yatsuzuka
Head Office	3, Minamiochiai-cho, Kisshoin, Minami-ku, Kyoto, 601-8326 JAPAN
Date of Establishment	1937
Capitalization	100 million yen
No. of employees	158
Sales office	Niigata, Tokyo, Nagoya, Kyoto, Hyogo and Fukuoka
Manufacturing factories	Oita (JAPAN), KDS Malaysia (MALAYSIA)
Distribution Center	Shiga, Rotterdam,
Overseas Office	Chicago (USA)
Co-operated overseas manufactures	STABILA (GERMANY) SORTIMO (GERMANY) SUNSHINE MAKERS (USA)
ISO Certified	ISO 9001 JQA-1564 (MURATEC-KDS Corp.) ISO 9001 (KDS Malaysia)

## MURATEC-KDS CORP.

**MURATEC-KDS CORPORATION HEAD OFFICE**  
3, Minamiochiai-cho, Kisshoin, Minami-ku, Kyoto, 601-8326 JAPAN  
TEL. +81-75-681-2761 FAX. +81-75-661-2764  
E-mail : mailto:muratec-kds.jp

**CHICAGO correspondent**  
2026 West Cortez St.Chicago, IL60622-3630 U.S.A  
TEL. +1-773-252-1314 FAX. +1-773-252-1319  
E-mail: kevin.carter.kds@muratec-usa.com

**KDS Manufacturing (M) Sdn Bhd**  
Lot 7963, Batu 22, Jalan Air Hitam, 81000 Kulai, Johor, Malaysia  
E-mail: sales@kds-ml.com.my

<http://www.muratec-kds.jp/en/>

## Display Stands

**A-type Stand** ▶  
10 pcs of hook

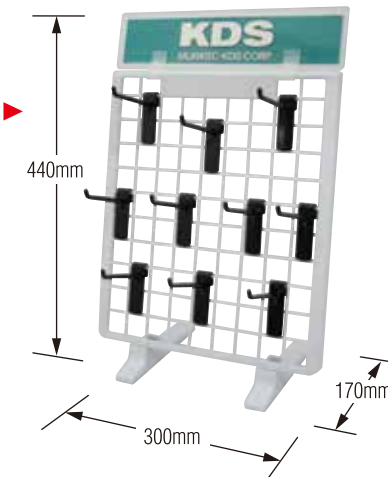

**Revolving Stand** ▶  
30pcs of hook

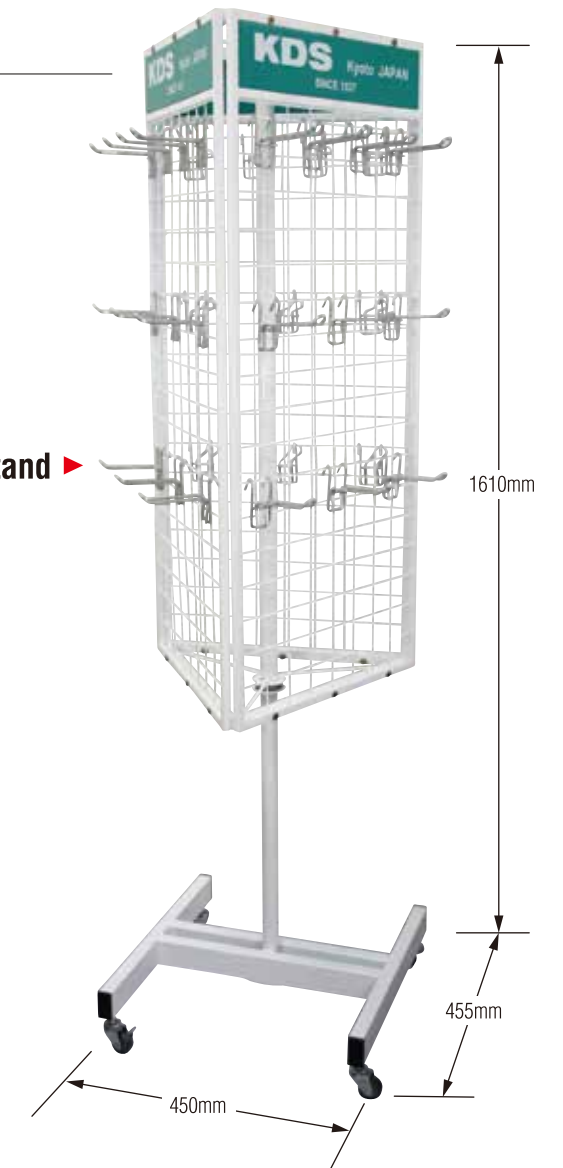

## JAPAN DIY HOMECENTER SHOW 2018



# INDEX

Products line up

**Cutters** 05 ~ 30

**Spare Blades** 31 ~ 45

**Safety-Bases** 46

**Scissors** 47

**Scrapers** 48 ~ 49

**Other Tools** 50 ~ 51·78

**Poket Tapes** 52 ~ 69

**Long Tapes** 70 ~ 74

**Electronic Products** 75 ~ 77

**Wooden Chisels / Planers** 79



# Cutters



Cutters

**Feel the difference ! KDS cutters are unique !**

## 1. EXTRA BLADES INCLUDED

Use up your blade on the job ?  
Just open end cap and pull out spare blade !

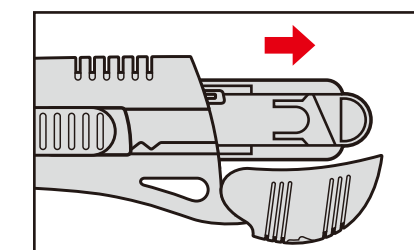

## 2. CHOOSE YOUR LOCK

Select the lock that you prefer : Auto-lock, Screw lock, or Safety lock.  
All locks hold the blade securely.

### Auto-Lock

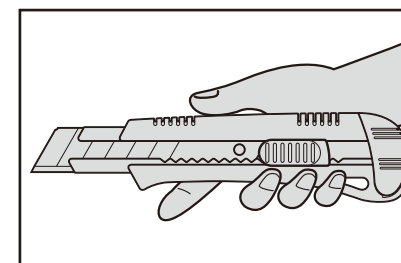



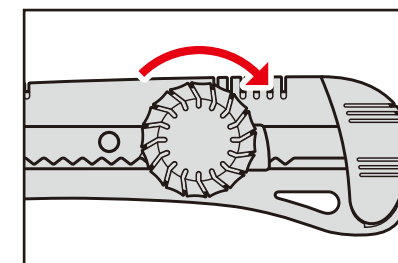

### Screw Lock

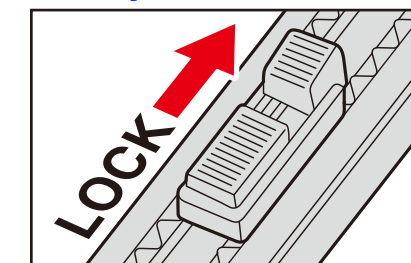

### Safety Lock



 × 3 (1+2) : Come with 3 blade(s)  
  : Blister Packed  
  : Plastic Bag  
 : With Power Black Evolution Blade(s)  
  : Paper Box



## Cutters



### L-34 Auto Lock



**NEW**

**EVO**



New Heavy-duty cutter with automated locking slider and lanyard hole. Ergonomically designed body shape perfectly stay in your palm. Supplied with **one blade**.

Cat.No.	Handle color	Suitable blade	QTY/ Inner carton	QTY/ Outer carton	N.W. (kgs)	G.W. (kgs)	M3	Carton size (Cm) D x W x H	EAN	Stock available in Rotterdam
L-34YE	Yellow	LB-10 EVO	10	100	10	12	0.068	36.3 x 76 x 24.5	4954183 563844	○

### L-35 Twist Lock



**NEW**

**EVO**



New Heavy-duty cutter with twist locking slider and lanyard hole. Ergonomically designed body shape perfectly stay in your palm. Supplied with **one blade**.

Cat.No.	Handle color	Suitable blade	QTY/ Inner carton	QTY/ Outer carton	N.W. (kgs)	G.W. (kgs)	M3	Carton size (Cm) D x W x H	EAN	Stock available in Rotterdam
L-35YE	Yellow	LB-10 EVO	10	100	10	12	0.068	36.3 x 76 x 24.5	4954183 563851	○

## Cutters Package-Deals

### LC-405 5H



**EVO**

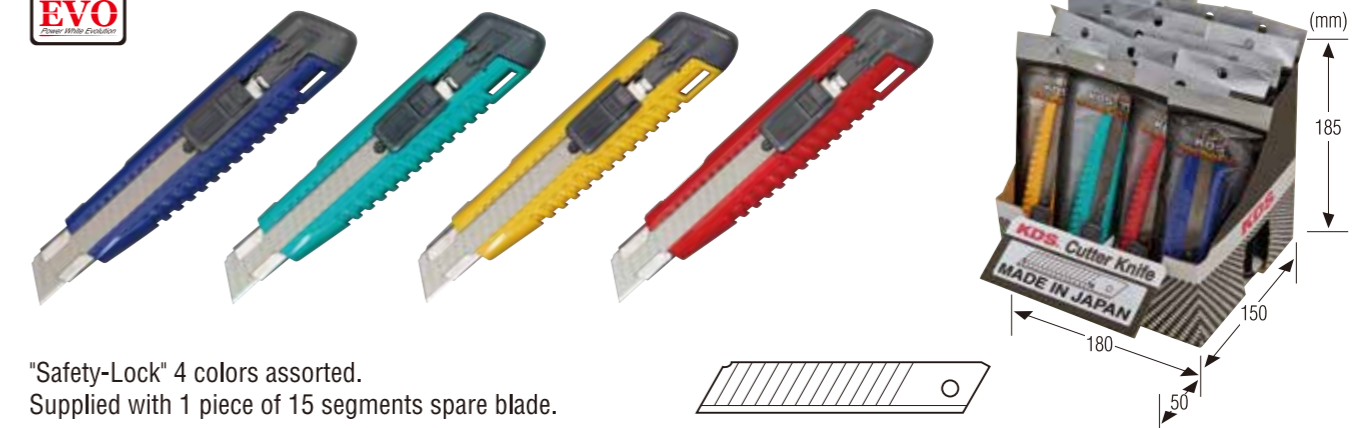

"Safety-Lock" 4 colors assorted. Supplied with 1 piece of 15 segments spare blade.

Cat.No.	Handle color	Suitable blade	QTY/ Inner carton	QTY/ Outer carton	N.W. (kgs)	G.W. (kgs)	M3	Carton size (Cm) D x W x H	EAN	Stock available in Rotterdam
LC-405 5H	Blue, Green, Yellow and Red (each 5 pcs. Per set)	LB-10W EVO	20	80	8	10	0.026	32 x 38.3 x 21.2	4954183 527501	○

### L-18 5H



**EVO**



"Auto-Lock" 4 colors assorted. Supplied with 1 piece of 15 segments blade. Without spare blade and

Cat.No.	Handle color	Suitable blade	QTY/ Inner carton	QTY/ Outer carton	N.W. (kgs)	G.W. (kgs)	M3	Carton size (Cm) D x W x H	EAN	Stock available in Rotterdam
L-18 5H	Blue, Green, Yellow and Red (each 5 pcs. Per set)	LB-10W EVO	20	80	7	9	0.026	32 x 38.3 x 21.2	4954183 527495	○

### L-19 5H



**EVO**



"Twist-Lock" 4 colors assorted. Supplied with 1 piece of 15 segments blade. Without spare blade and spare blade holder.

Cat.No.	Handle color	Suitable blade	QTY/ Inner carton	QTY/ Outer carton	N.W. (kgs)	G.W. (kgs)	M3	Carton size (Cm) D x W x H	EAN	Stock available in Rotterdam
L-19 5H	Blue, Green, Yellow and Red (each 5 pcs. Per set)	LB-10W EVO	20	80	7	9	0.026	32 x 38.3 x 21.2	4954183 527488	○



## Package-Deals

### H-12YE-3B Job Boss Pro Value pack



18 knives in a display box

Heavy-duty knife with strong ABS plastic body. Screw type slider securely locks the blade in place.

**3 Bonus blades in a storage case.**

Cat.No.	Handle color	Suitable blade	QTY/ Inner carton	QTY/ Outer carton	N.W. (kgs)	G.W. (kgs)	M3	Carton size (Cm) D x W x H	EAN	Stock available in Rotterdam
H-12YE-3B	Yellow	HB-10B EVO	18	18	5	7	0.031	25.5 x 42 x 28.5	4954183 511500	×

### S-21 Easy Slim



Front

Reverse



Fine-slider



Blade snapper



Nylon bag for hanging

Blade: 9mm(S-type)

Small size cutter with fine-slider for delicate cutting work.

Supplied with **one blade.**

Cat.No.	Handle color	Suitable blade	QTY/ Inner carton	QTY/ Outer carton	N.W. (kgs)	G.W. (kgs)	M3	Carton size (Cm) D x W x H	EAN	Stock available in Rotterdam
★S-21	Yellow	SB-10 EVO	20	240	1.5	2.5	0.012	24 x 30 x 16	4954183 562922	○

## Cutters

25 mm

### Extra Heavy Duty blades

#### H-Blades

H-Blades are 40% thicker than standard L-Blades.

Recommended for cutting tough materials like plaster board.

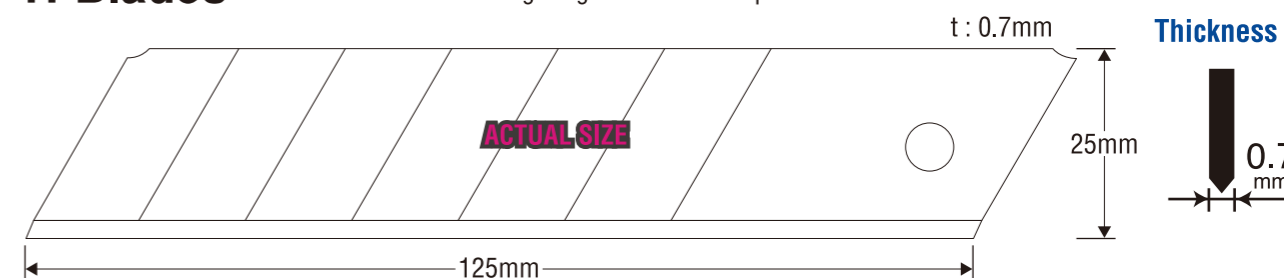

**Application :** for all H-type cutters H-11 H-12 H-12YE-3B H-13 H-15



G-18 mm

### Heavy Duty PRO blades

#### G-Blades

G-Blades are 20% thicker than standard L-Blades and suit for more solid job.

Other dimensions are same as L-Blades.



**Application :** for all G-type cutters and GG scrapers



18 mm

### Heavy Duty blades

#### L-Blades

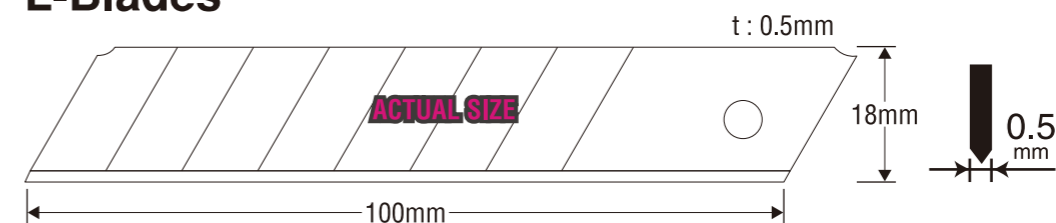

**Application :** for all L-type cutters and GG scrapers



9 mm

### Standard Duty blades

#### S-Blades

S-Blade is most popular standard cutter for general cutting.



**Application :** for S-11B S-12 S-13 S-14 S-21 S-22





## Cutters

**25 mm H-Blades** H-Blades are 40% thicker than standard L-Blades. Recommended for cutting tough materials like plaster board.

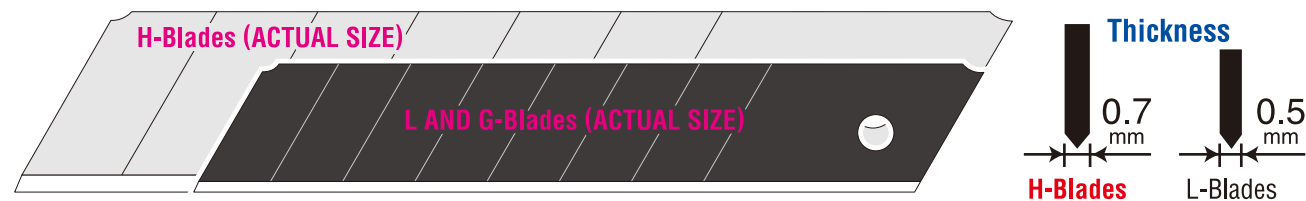

### H-11 Job Boss

YE RE



EVO



Super heavy duty knife with soft rubber grip. Screw type slider securely locks the blade in place.

Cat.No.	Handle color	Suitable blade	QTY/ Inner carton	QTY/ Outer carton	N.W.(kgs)	G.W.(kgs)	M3	Carton size (Cm) D x W x H	EAN	Stock available in Rotterdam
★ H-11YE	Yellow	HB-10 EVO	10	100	20	22	0.079	43.3 x 68 x 26.8	4954183 542252	○
H-11RE	Red								4954183 542245	

### H-12 Job Boss Pro

YE RE



EVO



Heavy-duty knife with strong ABS plastic body. Supplied with **one Power Black H-Blade**.

Cat.No.	Handle color	Suitable blade	QTY/ Inner carton	QTY/ Outer carton	N.W.(kgs)	G.W.(kgs)	M3	Carton size (Cm) D x W x H	EAN	Stock available in Rotterdam
★ H-12YE	Yellow	HB-10B EVO	10	100	18	20	0.080	34.8 x 76.3 x 30	4954183 561222	○
H-12RE	Red								4954183 561345	

### H-13 Job Boss SoftGrip



EVO



Heavy-duty knife with elastomer body. Supplied with **one Power Black H-Blade**. Screw type slider securely locks the blade in place.

Cat.No.	Handle color	Suitable blade	QTY/ Inner carton	QTY/ Outer carton	N.W.(kgs)	G.W.(kgs)	M3	Carton size (Cm) D x W x H	EAN	Stock available in Rotterdam
★ H-13	Gray	HB-10B EVO	10	100	17	19	0.080	34.8 x 76.3 x 30	4954183 561260	○

## Cutters

### H-15 Grip Fit AutoLock



NEW EVO



Rubberized, non-slip grip cutter with automated locking slider. Supplied with **one Power Black blade**.

Cat.No.	Handle color	Suitable blade	QTY/ Inner carton	QTY/ Outer carton	N.W.(kgs)	G.W.(kgs)	M3	Carton size (Cm) D x W x H	EAN	Stock available in Rotterdam
H-15	Yellow	HB-10B EVO	10	100	20kg	22kg	0.084	44 x 68 x 28	4954183 563011	○

### G-18 mm G-Blades

G-Blades are 20% thicker than standard L-Blades and suit for more solid job. Other dimensions are same as L-Blades.

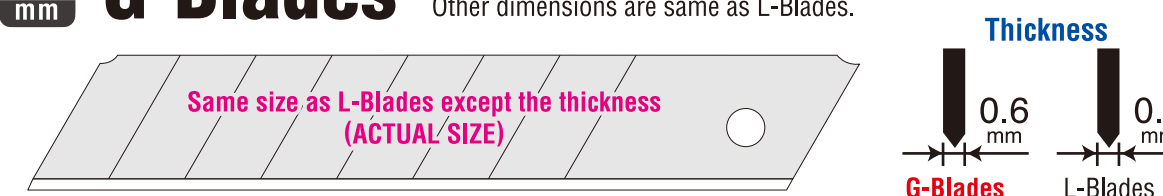

### G-11 Safety G

YE RE



EVO



Extra heavy-duty texture for long use and good grip with **0.6mm thick blade**. With **2 spare blades stored in the handle**.

Cat.No.	Handle color	Suitable blade	QTY/ Inner carton	QTY/ Outer carton	N.W.(kgs)	G.W.(kgs)	M3	Carton size (Cm) D x W x H	EAN	Stock available in Rotterdam
G-11YE	Yellow	GB-10 EVO	10	100	11	13	0.049	32 x 61 x 25	4954183 542290	○
G-11RE	Red								4954183 542276	

### GC-401



EVO



Extra heavy-duty texture for long use and good grip with 0.6mm thick blade. With **2 spare blades stored in the handle**.

Cat.No.	Handle color	Suitable blade	QTY/ Inner carton	QTY/ Outer carton	N.W.(kgs)	G.W.(kgs)	M3	Carton size (Cm) D x W x H	EAN	Stock available in Rotterdam
GC-401	Orange	GB-10 EVO	20	200	22	24	0.054	36.8 x 55.3 x 26.5	4954183 515416	○



## Cutters

### Grip Fit Series



### G-15 Grip Fit AutoLock G



Rubberized, non-slip grip cutter with automated locking slider.  
Supplied with 0.6mm thick Power Black Blades. **2 spare blades stored in the handle.**

Cat.No.	Handle color	Suitable blade	QTY/ Inner carton	QTY/ Outer carton	N.W.(kgs)	G.W.(kgs)	M3	Carton size (Cm) D x W x H	EAN	Stock available in Rotterdam
G-15	Yellow	GB-10B EVO	10	100	12	14	0.068	36.3 x 76 x 24.5	4954183 561512	○

### G-16 Grip Fit TwistLock G



Rubberized, non-slip grip cutter with twist locking slider.  
Supplied with 0.6mm thick Power Black Blades. **2 spare blades stored in the handle.**

Cat.No.	Handle color	Suitable blade	QTY/ Inner carton	QTY/ Outer carton	N.W.(kgs)	G.W.(kgs)	M3	Carton size (Cm) D x W x H	EAN	Stock available in Rotterdam
★ G-16	Yellow	GB-10B EVO	10	100	12	14	0.068	36.3 x 76 x 24.5	4954183 561529	○

## Cutters

### 18 mm L-Blades

### L-11 Safety L



L-11YE

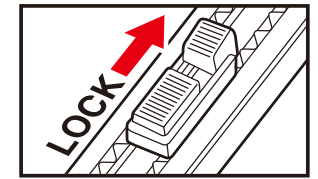

L-11RE

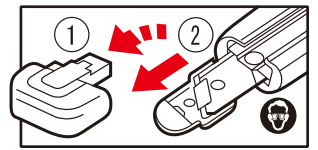

L-11B



One-handed safety lock. Supplied with **2 spare blades stored in the handle.**

Cat.No.	Handle color	Suitable blade	QTY/ Inner carton	QTY/ Outer carton	N.W.(kgs)	G.W.(kgs)	M3	Carton size (Cm) D x W x H	EAN	Stock available in Rotterdam
L-11YE	Yellow	LB-10 EVO	10	100	11	13	0.049	32 x 61 x 25	4954183 542320	○
L-11RE	Red								4954183 548827	
L-11B	Black	LB-10B EVO							4954183 507213	×

### LC-405

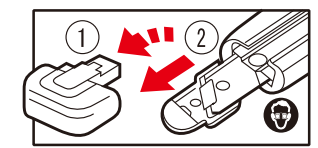

One-handed safety lock. Supplied with **2 spare blades stored in the handle.**



Cat.No.	Handle color	Suitable blade	QTY/ Inner carton	QTY/ Outer carton	N.W.(kgs)	G.W.(kgs)	M3	Carton size (Cm) D x W x H	EAN	Stock available in Rotterdam
LC-405	Orange	LB-10 EVO	20	200	20	22	0.054	36.8 x 55.3 x 26.5	4954183 515614	×



## Cutters

### L-15 Big Twist

YE RE



EVO

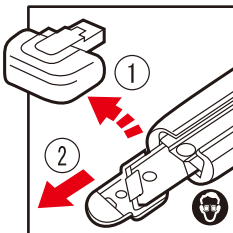

Multi-purpose screw type cutter for professional use, with **2 spare blades stored in the handle.**

Cat.No.	Handle color	Suitable blade	QTY/ Inner carton	QTY/ Outer carton	N.W.(kgs)	G.W.(kgs)	M3	Carton size (Cm) D x W x H	EAN	Stock available in Rotterdam
L-15YE	Yellow	LB-10 EVO	10	100	12	14	0.079	43.3 x 68 x 26.8	4954183 542238	○
L-15RE	Red								4954183 542214	×

### L-18EL 雅 (Mi-Ya-Bi) The Elegance

RE BL



Why must hand tools be so plain?  
Add style to your tools with the KDS 雅(Mi-Ya-Bi), which means "The Elegance".  
With the KDS 雅(Mi-Ya-Bi), be proud to express your personality and stand out in the crowd!

**1 spare blade stored in the handle.**

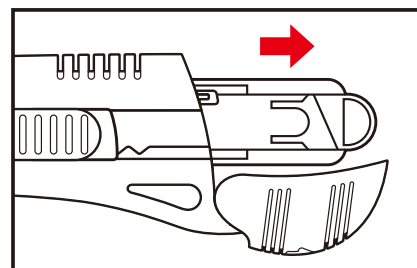

Cat.No.	Handle color	Suitable blade	QTY/ Inner carton	QTY/ Outer carton	N.W.(kgs)	G.W.(kgs)	M3	Carton size (Cm) D x W x H	EAN	Stock available in Rotterdam
L-18EL RE	Metallic Red	LB-10B EVO	10	60	6	8	0.033	37 x 48.5 x 18.3	4954183 525262	×
L-18EL BL	Metallic Blue								4954183 525279	

## Cutters

### L-18 Auto Lock

YE RE BK



L-18YE

EVO

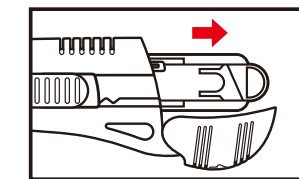

L-18RE

EVO



L-18YEB

EVO



L-18B

EVO



"Auto-Lock" cutter with automated locking slider. Supplied with **2 spare blades stored in the handle.**

Cat.No.	Handle color	Suitable blade	QTY/ Inner carton	QTY/ Outer carton	N.W.(kgs)	G.W.(kgs)	M3	Carton size (Cm) D x W x H	EAN	Stock available in Rotterdam
L-18YE	Yellow	LB-10 EVO	10	100	11	13	0.068	36.3 x 76 x 24.5	4954183 554064	○
L-18RE	Red								4954183 554057	
★L-18YEB	Yellow	LB-10B EVO	10	100	11	13	0.068	36.3 x 76 x 24.5	4954183 522049	×
L-18B	Black								4954183 507237	



## Cutters

### L-19 Twist L

YE RE BK

 × 3 (1+2) 

L-19YE

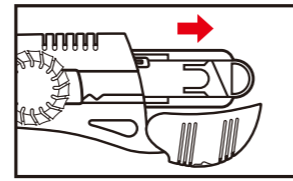

L-19RE



L-19YEB



L-19B



"Twist-Lock" for safe and secure cutting. With **2 spare blades stored in the handle.**

Cat.No.	Handle color	Suitable blade	QTY/ Inner carton	QTY/ Outer carton	N.W.(kgs)	G.W.(kgs)	M3	Carton size (Cm) D x W x H	EAN	Stock available in Rotterdam
L-19YE	Yellow	LB-10 EVO	10	100	11	13	0.068	36.3 x 76 x 24.5	4954183 554088	○
L-19RE	Red								4954183 554071	×
★L-19YEB	Yellow	LB-10B EVO	10	100	11	13	0.068	36.3 x 76 x 24.5	4954183 522056	×
L-19B	Black								4954183 507206	×

## Cutters

### L-18SS STAINLESS Blade AutoLock

 × 1 



Stainless steel blade

Auto-lock cutter with STAINLESS BLADE.

This knife is recommended for outdoor or wet working environments.

Cat.No.	Handle color	Suitable blade	QTY/ Inner carton	QTY/ Outer carton	N.W.(kgs)	G.W.(kgs)	M3	Carton size (Cm) D x W x H	EAN	Stock available in Rotterdam
L-18SS	Black	LB-10S EVO	10	100	10	12	0.068	36.3 x 76 x 24.5	4954183 521554	×

### L-21 Auto Feeder

YE RE

 × 3 

L-21YE



L-21RE



A three-blade, auto-feeding magazine to keep a sharp edge for a longer time. **Three L-blades pre-loaded.**

Auto-lock for regular use and a pro screw lock for power cuts.

**Both LB blade(0.5mm thickness) and GB blade(0.6mm thickness) fits the body.**

Cat.No.	Handle color	Suitable blade	QTY/ Inner carton	QTY/ Outer carton	N.W.(kgs)	G.W.(kgs)	M3	Carton size (Cm) D x W x H	EAN	Stock available in Rotterdam
L-21YE	Yellow	LB-10 EVO and GB-10 EVO	10	100	12	14	0.079	32 x 61x 25	4954183 559946	○
L-21RE	Red								4954183 559953	×



## Cutters

### Grip Fit Series



#### ★ L-22 GripFit AutoLock L



Rubberized, non-slip grip cutter with automated locking slider. Supplied with Power Black Blades.  
**2 spare blades stored in the handle.**

Cat.No.	Handle color	Suitable blade	QTY/ Inner carton	QTY/ Outer carton	N.W.(kgs)	G.W.(kgs)	M3	Carton size (Cm) D x W x H	EAN	Stock available in Rotterdam
★ L-22	Yellow	LB-10B EVO	10	100	14	16	0.068	36.3 x 76 x 24.5	4954183 509132	○

#### ★ L-23 GripFit TwistLock L



Rubberized, non-slip grip cutter with twist lock slider. Supplied with Power Black Blades. **2 spare blades stored in the handle.**

Cat.No.	Handle color	Suitable blade	QTY/ Inner carton	QTY/ Outer carton	N.W.(kgs)	G.W.(kgs)	M3	Carton size (Cm) D x W x H	EAN	Stock available in Rotterdam
★ L-23	Yellow	LB-10B EVO	10	100	14	16	0.068	36.3 x 76 x 24.5	4954183 509149	○

## Cutters

### MultiPro Series



#### ★ L-24 MultiPro AutoLock L



"MultiPro L series" is not only for cutting.  
 Can be used for tucking carpet, prying lids off paint and other cans,  
 and scoring & cut cardboard to make boxes. Supplied with **One Power Black Blade.**

Cat.No.	Handle color	Suitable blade	QTY/ Inner carton	QTY/ Outer carton	N.W.(kgs)	G.W.(kgs)	M3	Carton size (Cm) D x W x H	EAN	Stock available in Rotterdam
L-24	Yellow	LB-10B EVO	10	100	8	10	0.068	36.3 x 76 x 24.5	4954183 510749	○

#### ★ L-25 MultiPro TwistLock L



"MultiPro L series" is not only for cutting.  
 Can be used for tucking carpet, prying lids off paint cans,  
 and scoring & cut cardboard to make boxes. Supplied with **One Power Black Blade.**

Cat.No.	Handle color	Suitable blade	QTY/ Inner carton	QTY/ Outer carton	N.W.(kgs)	G.W.(kgs)	M3	Carton size (Cm) D x W x H	EAN	Stock available in Rotterdam
★ L-25	Yellow	LB-10B EVO	10	100	8	10	0.068	36.3 x 76 x 24.5	4954183 510756	○



## Cutters

### L-30 Finger Guard



Good fit with SAW blade(HSB) to cut Wood and Plasterboard.

Recommendable for professionals as well as DIY users. Finger protection arm stabilizes cutting depth and prevent from skidding of knife in your palm. Screw type slider securely locks the blade in place. Supplied with Power Black Blades. **2 spare blades stored in the handle.**

Cat.No.	Handle color	Suitable blade	QTY/ Inner carton	QTY/ Outer carton	N.W.(kgs)	G.W.(kgs)	M3	Carton size (Cm) D x W x H	EAN	Stock available in Rotterdam
L-30	Yellow	LB-10B EVO	10	100	10	12	0.068	38.8 x 85 x 26	4954183 561604	×

### L-32 Metal Meister Twist Lock



Aluminum die-cast body with twist locking slider. Ergonomically designed body shape perfectly stay in your palm. End cap works as a blade snapper. Supplied with **one Power Black blade.**

Cat.No.	Handle color	Suitable blade	QTY/ Inner carton	QTY/ Outer carton	N.W.(kgs)	G.W.(kgs)	M3	Carton size (Cm) D x W x H	EAN	Stock available in Rotterdam
★L-32	Metallic Gray	LB-10B EVO	10	60	7.7	8.7	0.026	42 x 23.5 x 26	4954183 530655	○

### L-33 Metal Meister Auto Lock



Aluminum die-cast body with automated locking slider. Ergonomically designed body shape perfectly stay in your palm. End cap works as a blade snapper. Supplied with **one Power Black blade.**

Cat.No.	Handle color	Suitable blade	QTY/ Inner carton	QTY/ Outer carton	N.W.(kgs)	G.W.(kgs)	M3	Carton size (Cm) D x W x H	EAN	Stock available in Rotterdam
L-33	Metallic Gray	LB-10B EVO	10	60	8	9	0.026	42 x 23.5 x 26	4954183 563363	○

## Cutters

### 9 mm S-Blades

S-Blade is most popular standard cutter for general cutting.

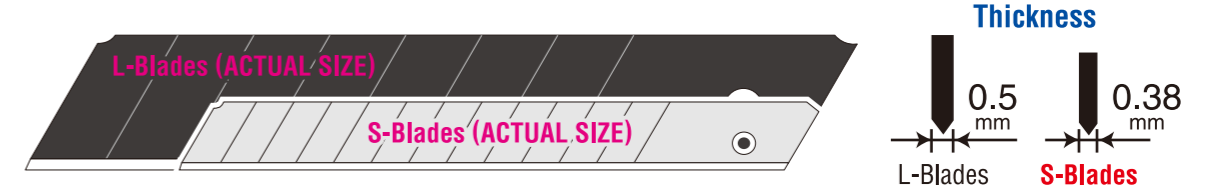

### S-11B Slim Black



Stainless frame with sliding lock. One slide position matches every break point of the multiple break-off blade. With **2 spare blades.**

Cat.No.	Handle color	Suitable blade	QTY/ Inner carton	QTY/ Outer carton	N.W.(kgs)	G.W.(kgs)	M3	Carton size (Cm) D x W x H	EAN	Stock available in Rotterdam
★S-11B	Silver	SB-10B EVO	10	200	8.5	9.5	0.047	24.5 x 43 x 44	4954183 532130	○

### S-12 Metal Slim



Stainless frame with sliding lock. One slide position matches every break point of the multiple break-off blade. With **2 spare blades.**

Cat.No.	Handle color	Suitable blade	QTY/ Inner carton	QTY/ Outer carton	N.W.(kgs)	G.W.(kgs)	M3	Carton size (Cm) D x W x H	EAN	Stock available in Rotterdam
S-12	Silver	SB-10 EVO	10	200	8.4	9.4	0.047	24.5 x 43 x 44	4954183 542016	○

### S-13 Dura Slim



S-13BL



S-13GR



Electronic powder coated metal frame with sliding lock. 9 mm snap-off with 13 segments. With **2 spare blades.**

Cat.No.	Handle color	Suitable blade	QTY/ Inner carton	QTY/ Outer carton	N.W.(kgs)	G.W.(kgs)	M3	Carton size (Cm) D x W x H	EAN	Stock available in Rotterdam
★S-13BL	Blue	SB-10 EVO	10	200	8.4	9.4	0.048	22.5 x 48.5 x 44	4954183 542047	○
S-13GR	Green								4954183 542061	

## Cutters

### S-14 Pocket Slim

YE GR BL

 × 3 (1+2) 

S-14YE



S-14BL



S-14GR



S-14YEB



Impact resistant body in high-quality ABS material, with metal blade sleeve. 9 mm snap-off with 13 segments. With **2 spare blades**.

Cat.No.	Handle color	Suitable blade	QTY/ Inner carton	QTY/ Outer carton	N.W.(kgs)	G.W.(kgs)	M3	Carton size (Cm) D x W x H	EAN	Stock available in Rotterdam
S-14YE	Yellow	SB-10 EVO	10	200	8.4	9.4	0.047	24.5 x 43 x 44	4954183 542108	○
S-14BL	Blue								4954183 542092	
S-14GR	Green								4954183 542115	
★S-14YEB	Yellow								4954183 521363	

#### Non - SPARE BLADE

YE BL

 × 1 

S-14YE NB	Yellow	SB-10 EVO	10	200	8.4	9.4	0.047	24.5 x 43 x 44	4954183 525316	×
S-14BL NB	Blue								4954183 525323	

### S-18 Slim Trim

 × 1 

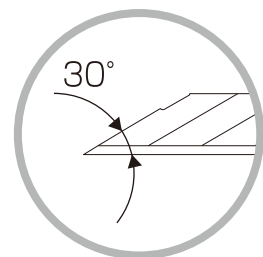

Snap-Edge Cutter is most convenient for delicate cutting work, with special **30 degree angle blade**.

Suitable blade : VB-10 EVO

Cat.No.	Handle color	Suitable blade	QTY/ Inner carton	QTY/ Outer carton	N.W.(kgs)	G.W.(kgs)	M3	Carton size (Cm) D x W x H	EAN	Stock available in Rotterdam
★S-18	Silver	VB-10 EVO	10	200	7	8	0.047	24.5 x 43 x 44	4954183 553692	○

## Cutters

### S-22 Grip Fit AutoLock

 × 1 

**NEW**



Rubberized, non-slip grip cutter with automated locking slider. End cap works as a blade snapper. Supplied with **one Power Black blade**.

Cat.No.	Handle color	Suitable blade	QTY/ Inner carton	QTY/ Outer carton	N.W.(kgs)	G.W.(kgs)	M3	Carton size (Cm) D x W x H	EAN	Stock available in Rotterdam
S-22	Yellow	SB-10B EVO	10	200	10	12	0.051	49.5 x 24.5 x 42	4954183 563004	○

### D-12 Easy Grip

BL YE GR

 × 16 





Most useful and convenient for all graphic work. Soft grip allows for precise use, and 10.5mm diameter body for tireless grip. With **16 pcs spare blades**.

Cat.No.	Handle color	Suitable blade	QTY/ Inner carton	QTY/ Outer carton	N.W.(kgs)	G.W.(kgs)	M3	Carton size (Cm) D x W x H	EAN	Stock available in Rotterdam
D-12BL	Blue	DB-48	10	200	7.6	8.6	0.048	22.5 x 48.5 x 44	4954183 555054	×
D-12YE	Yellow								4954183 557904	○
D-12GR	Green								4954183 555061	×

### P-11 Plastic Cutter

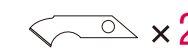
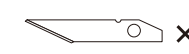
YE RE

 × 2  × 2 

P-11YE



P-11RE



PB-10

PB-10 A

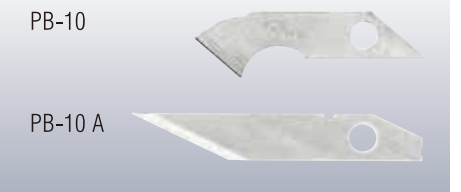

P-Cutter is most convenient for plastic cutting.

**2 straight and 1 hook blades stored in the handle.**

Cat.No.	Handle color	Suitable blade	QTY/ Inner carton	QTY/ Outer carton	N.W.(kgs)	G.W.(kgs)	M3	Carton size (Cm) D x W x H	EAN	Stock available in Rotterdam
P-11YE	Yellow	PB-10 (Hook blade)/ PB-10A (Sharper)	10	100	6.4	7.4	0.049	32 x 61 x 25	4954183 542375	×
P-11RE	Red								4954183 542368	



## Cutters

### T-11 Threeway

YE RE

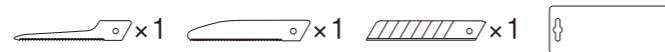

Multi-purpose cutter and standard / keyhole saws.  
Most useful for electricians, carpenters and gardeners.

Cat.No.	Handle color	Suitable blade	QTY/ Inner carton	QTY/ Outer carton	N.W.(kgs)	G.W.(kgs)	M3	Carton size (Cm) D x W x H	EAN	Stock available in Rotterdam
T-11YE	Yellow	All L-type blades, HSB-Z and HSB-W	5	50	9	11	0.062	39.3 x 47 x 33.3	4954183 542399	×
T-11RE	Red								4954183 542382	

### T-16 Standard Saw



NEW



A small portable saw for general or specific purposes.  
Most convenient for electricians and carpenters.  
The standard saw blade, which is made from steel, cuts general materials such as wood and plastic pipe.

(Japanese version package)

Cat.No.	Handle color	Suitable blade	QTY/ Inner carton	QTY/ Outer carton	N.W.(kgs)	G.W.(kgs)	M3	Carton size (Cm) D x W x H	EAN	Stock available in Rotterdam
T-16	Yellow	HSB-Z and HSB-W	10	100	8	10	0.058	36.3 x 76 x 24.5	4954183 169008	×

### T-17 Keyhole Saw



NEW



A small portable saw for general or specific purposes.  
Most convenient for electricians and carpenters.  
The keyhole saw, which is made from steel, can open holes in existing drywall or wood, as well as cut curved or intricate lines.

(Japanese version package)

Cat.No.	Handle color	Suitable blade	QTY/ Inner carton	QTY/ Outer carton	N.W.(kgs)	G.W.(kgs)	M3	Carton size (Cm) D x W x H	EAN	Stock available in Rotterdam
T-17	Yellow	HSB-Z and HSB-W	10	100	8	10	0.058	36.3 x 76 x 24.5	4954183 169015	×

## Cutters

### HOOK BLADE SERIES

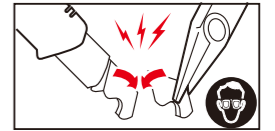
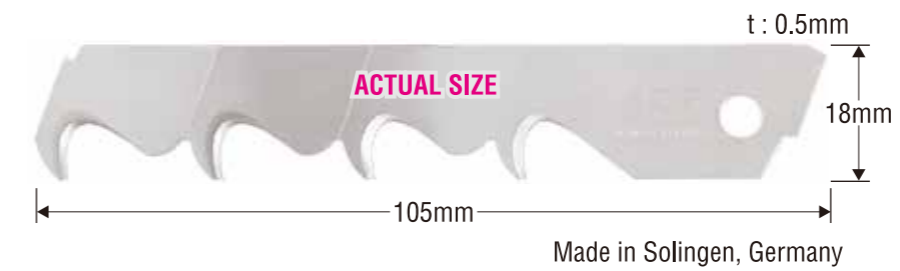

### HK-11 Twist L-Hook



Hook it! Slices through materials without damaging the surface. Use it for flooring and roofing, to cut strapping and boxes. **Supplied with 1 Hook Blade from Solingen, Germany.**

Cat.No.	Handle color	Suitable blade	QTY/ Inner carton	QTY/ Outer carton	N.W.(kgs)	G.W.(kgs)	M3	Carton size (Cm) D x W x H	EAN	Stock available in Rotterdam
HK-11	Yellow	HK-5 EVO	10	100	8	10	0.068	36.3 x 76 x 24.5	4954183 507787	○

### HK-12 MultiPro Hook it

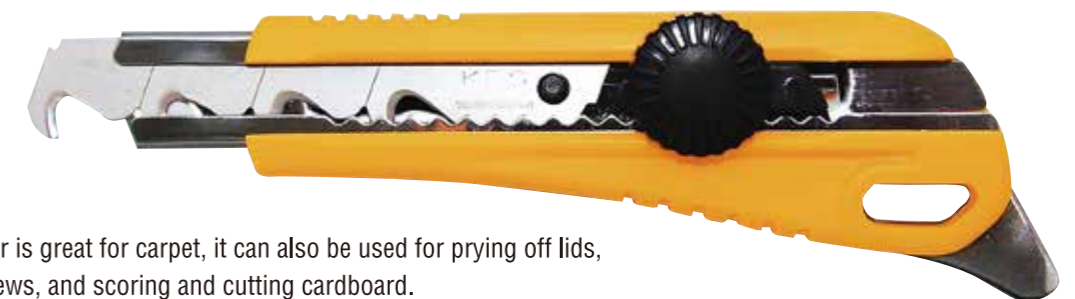

With the tucker is great for carpet, it can also be used for prying off lids, tightening screws, and scoring and cutting cardboard.  
The knife is loaded with a snap hook blade for cutting surface materials without damaging what is underneath.  
**Supplied with 1 Hook Blade from Solingen, Germany.**

Cat.No.	Handle color	Suitable blade	QTY/ Inner carton	QTY/ Outer carton	N.W.(kgs)	G.W.(kgs)	M3	Carton size (Cm) D x W x H	EAN	Stock available in Rotterdam
★HK-12	Yellow	HK-5 EVO	10	100	8	10	0.068	36.3 x 76 x 24.5	4954183 512323	×





## Cutters

### SA-11B Safety Master



**EVO**



Ergonomically designed safety knife changes the image of the common safety knife! Rubberized, non-slip grip and lightweight body for comfortable long-term use.

**One blade loaded and one spare in the handle.**



Anti-lock, recessed slider

One push open for blade change

Cat.No.	Handle color	Suitable blade	QTY/ Inner carton	QTY/ Outer carton	N.W. (kgs)	G.W. (kgs)	M3	Carton size (Cm) D x W x H	EAN	Stock available in Rotterdam
★SA-11B	Yellow	TB-5B/TB-50B	10	100	10	12	0.056	36.3 x 76 x 24.5	4954183 539948	×

### SA-12B Safety Metal



**EVO**



Aluminum die-cast body Safety cutter. Ergonomics design grip perfectly fits your palm. Suit for both Right and Left-handers.

**Comes with 5 spare blades.**

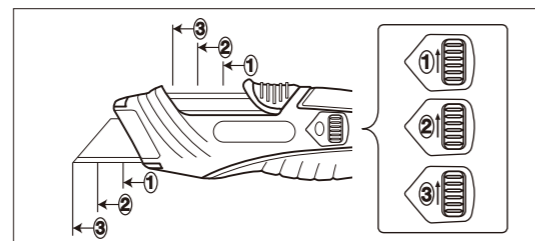

Cat.No.	Handle color	Suitable blade	QTY/ Inner carton	QTY/ Outer carton	N.W. (kgs)	G.W. (kgs)	M3	Carton size (Cm) D x W x H	EAN	Stock available in Rotterdam
★SA-12B	Metallic Silver	TB-5B/TB-50B	6	36	8.5	9.5	0.023	34.5 x 26.5 x 25	4954183 531959	○

## Cutters

### SA-14 Safety Metal Pro

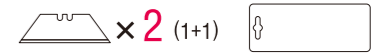

**NEW**

**EVO**



Even if the user forgets to release the slider, the knife can be used safely and effectively, because **CLICKED** blade always automatically retract.



**A spare blade in the handle.**  
(Can be opened without any tool)



Can be used for cutting strings

Self-Retracting safety knife provides an extra level of safety function.

The blade automatically retracts when it loses contact with the cutting materials, even if the slider is kept at the forward position.

**One blade loaded and one spare in the handle.**

Cat.No.	Handle color	Suitable blade	QTY/ Inner carton	QTY/ Outer carton	N.W. (kgs)	G.W. (kgs)	M3	Carton size (Cm) D x W x H	EAN	Stock available in Rotterdam
★SA-14	Black	TB-5B/TB-50B	6	36	8.7	9.5	0.021	27.5 x 24 x 30.5	4954183 531331	○



# Cutters

## Grip Fit Rotary



Grip fit rotary cutter with ergonomic, non-slip grip. Ideal for both left and right handed use without reassembling the cutter. Through the pressure on the blade, the unique blade guard adjusts its angle automatically. **A straight blade pre-loaded.**

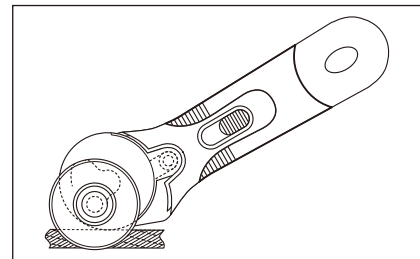

### RT-28 Grip Fit Rotary 28

**NEW**



The 28mm rotary cutter is best for small scale object. This blade size allows you to handle better along any patterns with many curves.

### RT-45 Grip Fit Rotary 45



The most popular cutter size "45mm" is available with the RT-45. Perfect for general cutting, quilting, sewing and craft projects.

### RT-60 Grip Fit Rotary 60

**NEW**













KDS's largest rotary cutter used a 60mm blade and can easily cut up to some layers of paper and fabric. This cutter is very useful for heavy fabrics and thick papers.

Cat.No.	Handle color	Suitable blade	QTY/ Inner carton	QTY/ Outer carton	N.W.(kgs)	G.W.(kgs)	M3	Carton size (Cm) D x W x H	EAN	Stock available in Rotterdam
RT-28	Yellow	RTB-28	12	96	9	10	0.036	41 x 52 x 16.5	4954183 562779	○
RT-45		RTB-45			10	11	0.052	27 x 51 x 39	4954183 524647	○
RT-60		RTB-60			11	12	0.054	41 x 52 x 25	4954183 562793	○

# Cutter packaging-1

Cat.No.	QTY/Inner carton	QTY/Outer carton	
<b>25mm</b>			
H-11YE		10	
H-11RE			
H-12YE			
H-12RE			
H-13			
H-15			
<b>G-18mm</b>			
G-11YE		10	Packed 10 inner cartons
G-11RE			
G-15			
G-16			
GC-401			
<b>18mm</b>			
LC-405		20	Packed 10 inner cartons
L-11YE			
L-11RE		10	Packed 10 inner cartons
L-11B			
L-15YE			
L-15RE			
L-18EL RE			
L-18EL BL			
L-18YE			
L-18RE			
L-18YEB			
L-18B			
L-19YE			
L-19RE			
L-19YEB			
L-19B			
L-18SS			
L-21YE			
L-21RE			
L-22			
L-23			
L-24			
L-25			
L-30			
L-32		10	Packed 6 inner cartons
L-33			
L-34		10	Packed 10 inner cartons
L-35			

## Cutter packaging-2

Cat.No.	QTY/Inner carton 	QTY/Outer carton 
<b>9mm</b>		
S-11B		Packed 20 inner cartons
S-12		
S-13BL		
S-13GR		
S-14YE		
S-14BL		
S-14GR		
S-14YEB		
S-14YE NB		
S-14BL NB		
S-18		
S-22		
<b>Others</b>		
D-12BL		Packed 10 inner cartons
D-12YE		
D-12GR		
P-11YE		
P-11RE		
T-11		
T-16		
T-17		
HK-11		
HK-12		
SA-11B		
SA-12B		Packed 6 inner cartons 
SA-14		
<b>Rotary Cutters</b>		Packed 8 inner cartons 
RT-28		
RT-45		
RT-60		
<b>Package-Deals</b>		Packed 4 inner cartons
LC-405 5H		
L-18 5H		
L-19 5H		
H-12YE-3B		Packed 1 inner cartons
S-21		
		Packed 12 inner cartons

## Spare Blades

# Hard but Pliable

KDS black blades have undergone the ideal heat treatment for cutter blades.

**Made in Japan**

The **Blade** is the heart of the knife.

KDS provides first class blades with over 40 years of know-how and strict quality control systems.



Press



Heat Treatment



Edging



Control board



Surface Inspecting



Cutting Test



Photo : OITA factory, JAPAN



# KDS® Evolution

An Evolution in Knife Blades  
KDS introduces the world's finest blades!



**SHARP EDGE**  
Designed for Maximum Sharpness



**DURABLE EDGE**  
Designed for Maximum Durability

## Why are EVO blades better?

### Quality Steel



Only the best steel for the best blades!

### Tempering



Tempered for the optimum balance of hardness and pliability.

### Honing Angles

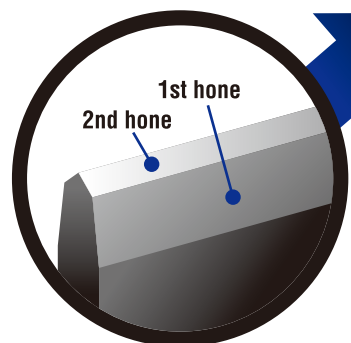

Double-honed, ideal for the job.

### Grinding

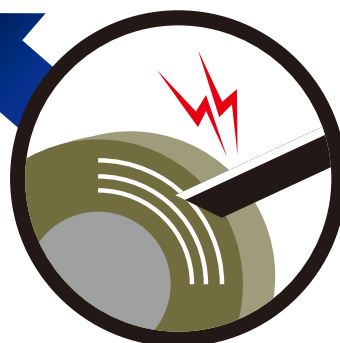

Ground for a smooth, clean cut.



## Paper cutting test

**Purpose : To test Blade Sharpness and Durability**

750g of weight is loaded on the blade, and the full blade is pulled through a stack of newsprint that is 7.5mm wide. After each pass, the number of cut sheets is measured. The test is repeated 32 times per blade.

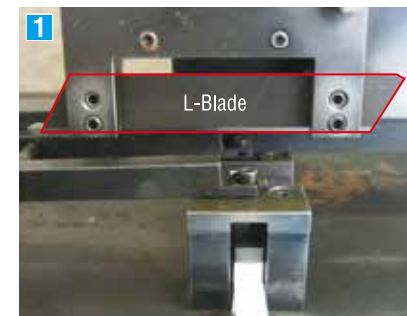

Step 1 : Setting up a blade



Step 2 : Cutting the paper with 750g weight

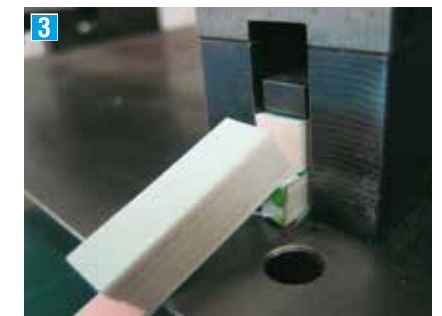

Step 3 : Measuring the cut sheets

## TEST RESULT

Based on our internal test

Number of sheets cut and number of passes made

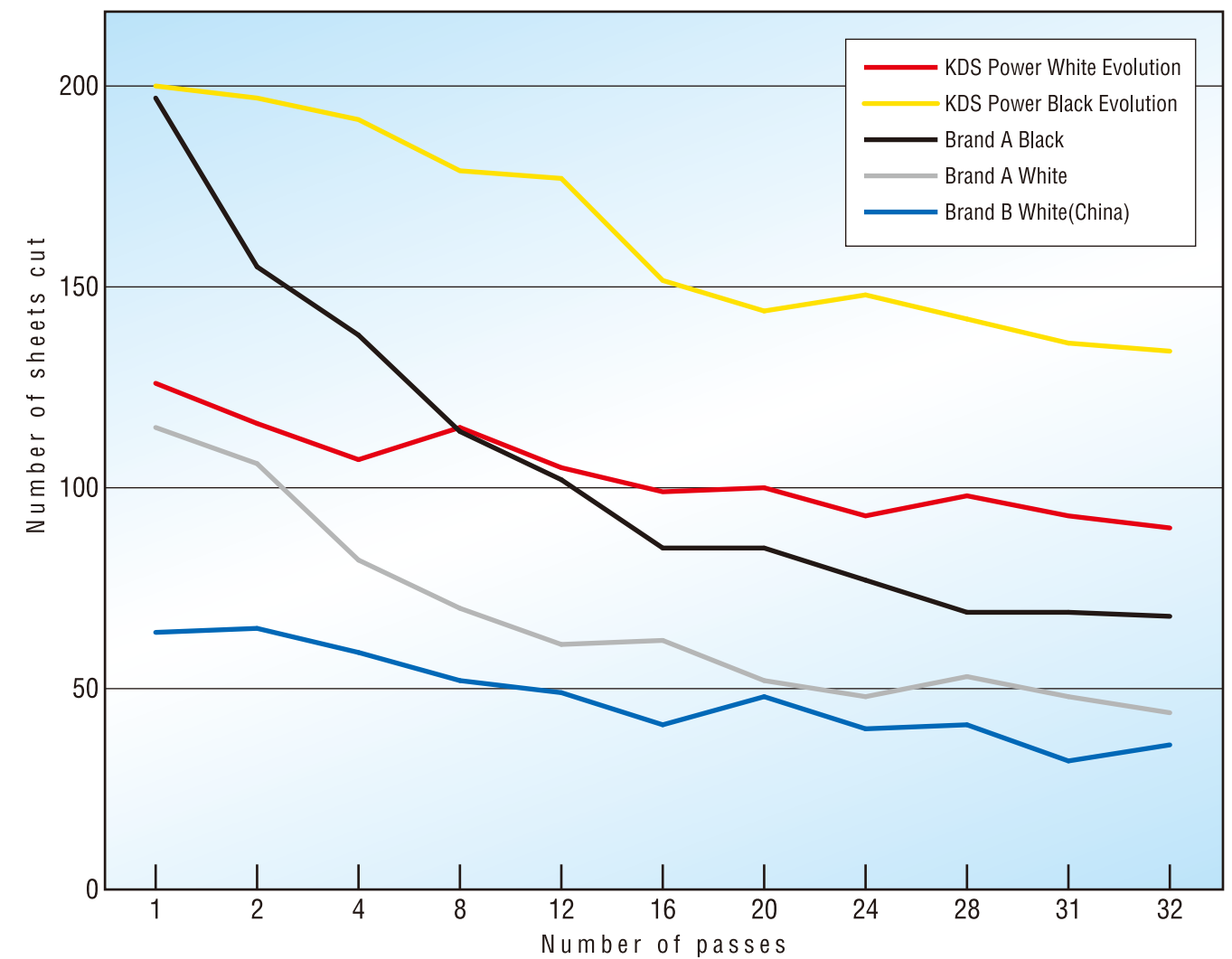

**Choose the blade that's right for the job!**

## Spare Blades Packaging

### Display box



9 mm

#### S-Blades

SB-10B EVO SB-50B EVO  
 SB-10 EVO SB-50 EVO  
 SB-10BNL EVO SB-50BNL EVO  
 SB-10NL EVO SB-50NL EVO  
 VB-10 EVO



G-18 mm

#### G-Blades

GB-10B EVO  
 GB-10 EVO  
 GB-10W EVO

18 mm

#### L-Blades

LB-10B EVO GB-50B EVO  
 LB-10 EVO GB-50 EVO  
 LB-10BW EVO GB-50W EVO  
 LB-10W EVO GB-50WOF EVO  
 LB-10BNL EVO  
 LB-10NL EVO LB-50B EVO  
 LB-10S EVO LB-50 EVO  
 HK-5 EVO LB-50W EVO  
 LB-50BNL EVO  
 LB-50NL EVO



#### Trapezoidal Blade

TB-5B

### Plain box



25 mm

#### H-Blades

HB-5B EVO HB-10BNL EVO  
 HB-10B EVO HB-10NL EVO  
 HB-10 EVO



#### Others

HSB-W PB-10  
 HSB-Z PB-10A  
 DB-45



#### Trapezoidal Blade

TB-50B

## Spare Blades

25 mm

### Extra Heavy Duty blades

#### H-Blades

H-Blades are 40% thicker than standard L-Blades.  
 Recommended for cutting tough materials like plaster board.

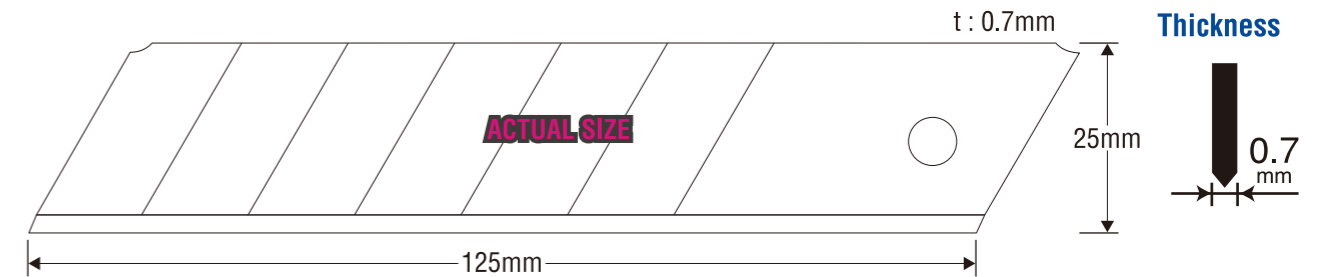

Application : for all H-type cutters H-11 H-12 H-12YE-3B H-13 H-15

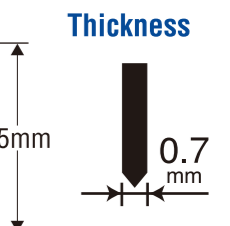

G-18 mm

### Heavy Duty PRO blades

#### G-Blades

G-Blades are 20% thicker than standard L-Blades and suit for more solid job.  
 Other dimensions are same as L-Blades.

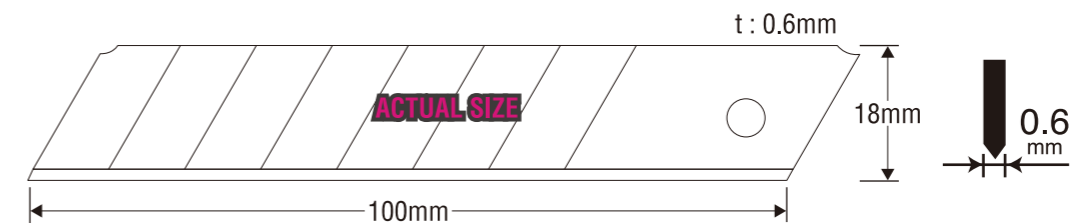

Application : for all G-type cutters and GG scrapers



18 mm

### Heavy Duty blades

#### L-Blades

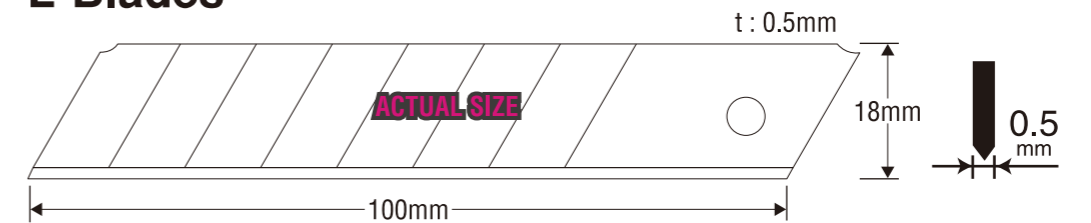

Application : for all L-type cutters and GG scrapers

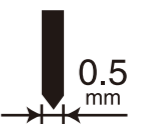

9 mm

### Standard Duty blades

#### S-Blades

S-Blade is most popular standard cutter for general cutting.

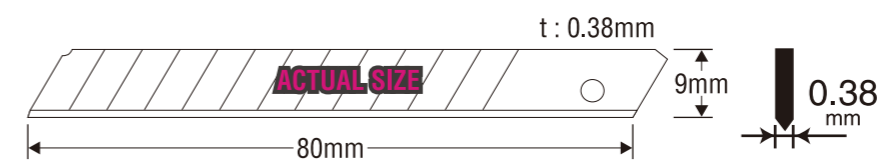

Application : for S-11B S-12 S-13 S-14 S-21 S-22





## Spare Blades

### Power Black Trapezoidal Blade

**NEW** KDS Trapezoidal blade is developed with the heat treatment technology of Power Black Evolution series.

#### Features:

- 1 High-quality steel (SK-120) with KDS's superior tempering process
- 2 KDS original double-hones, ideal for the job
- 3 Made in Japan by KDS



TB-5B

TB-50B



TB-5B inner carton

OPEN

Simply tear off the corner of the box, and this is how you can show to customers in your shelf.



STORAGE CASE

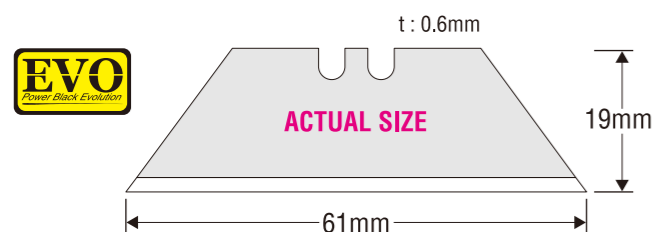

Application : SA-11B SA-12B SA-14

Cat.No.	Number of blades in a case	QTY/ Inner carton	QTY/ Outer carton	N.W. (kgs)	G.W. (kgs)	M3	Carton size (Cm) D x W x H	EAN	Stock available in Rotterdam
★TB-5B	5	20	200	9	10	0.012	27 x 24.5 x 17.5	4954183 530785	○
★TB-50B	50	8	48	13.5	14.5	0.047	61.5 x 31.5 x 24	4954183 530792	○

## Spare Blades

### H-Blades <sup>25mm</sup>

#### EVO SHARP EDGE

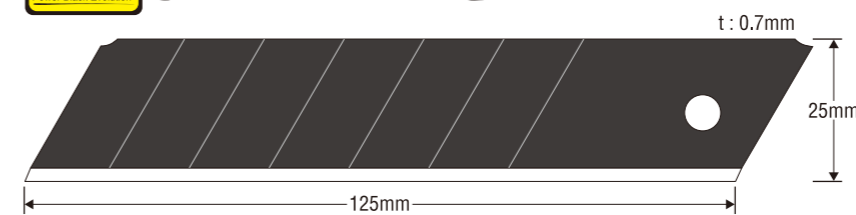

HB-5B EVO HB-10B EVO

Cat.No.	Number of blades in a case	QTY/ Inner carton	QTY/ Outer carton	N.W. (kgs)	G.W. (kgs)	M3	Carton size (Cm) D x W x H	EAN	Stock available in Rotterdam
★HB-5B EVO	5	10	100	10	12	0.006	17 x 19 x 18.5	4954183 524784	×
★HB-10B EVO	10			20	22			4954183 524791	○

#### EVO DURABLE EDGE

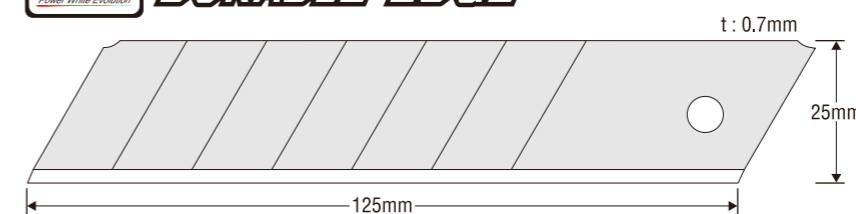

HB-10 EVO

Cat.No.	Number of blades in a case	QTY/ Inner carton	QTY/ Outer carton	N.W. (kgs)	G.W. (kgs)	M3	Carton size (Cm) D x W x H	EAN	Stock available in Rotterdam
★HB-10 EVO	10	10	100	20	22	0.006	17 x 19 x 18.5	4954183 524807	○

### Non-Snap Series Solid blades, non-snap blades for special purpose

#### EVO SHARP EDGE



HB-10BNL EVO

Cat.No.	Number of blades in a case	QTY/ Inner carton	QTY/ Outer carton	N.W. (kgs)	G.W. (kgs)	M3	Carton size (Cm) D x W x H	EAN	Stock available in Rotterdam
★HB-10BNL EVO	10	10	100	20	22	0.006	17 x 19 x 18.5	4954183 524814	×

#### EVO DURABLE EDGE



HB-10NL EVO

Cat.No.	Number of blades in a case	QTY/ Inner carton	QTY/ Outer carton	N.W. (kgs)	G.W. (kgs)	M3	Carton size (Cm) D x W x H	EAN	Stock available in Rotterdam
HB-10NL EVO	10	10	100	20	22	0.006	17 x 19 x 18.5	4954183 524821	×

## Spare Blades

### G-Blades G-18 mm

**EVO** SHARP EDGE

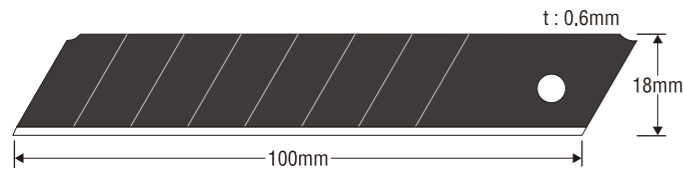

Cat.No.	Number of blades in a case	QTY/ Inner carton	QTY/ Outer carton	N.W. (kgs)	G.W. (kgs)	M3	Carton size (Cm) D x W x H	EAN	Stock available in Rotterdam
★GB-10B EVO	10	20	200	19	21	0.014	24 x 36 x 15.5	4954183 524715	○
★GB-50B EVO	50	10	50	21	23	0.011	15 x 45 x 16.5	4954183 524722	×

**EVO** DURABLE EDGE

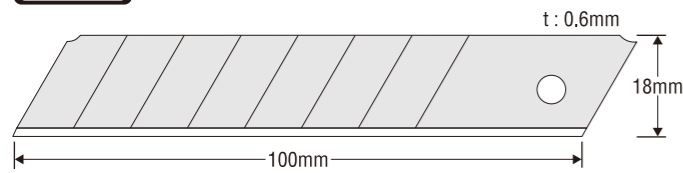

Cat.No.	Number of blades in a case	QTY/ Inner carton	QTY/ Outer carton	N.W. (kgs)	G.W. (kgs)	M3	Carton size (Cm) D x W x H	EAN	Stock available in Rotterdam
GB-10 EVO	10	20	200	19	21	0.014	24 x 36 x 15.5	4954183 524739	○
GB-50 EVO	50	10	50	21	23	0.011	15 x 45 x 16.5	4954183 524746	×

### 15 segments Blades

**EVO** DURABLE EDGE

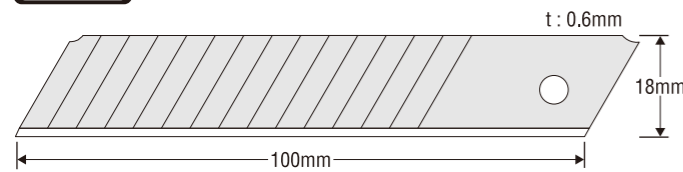

Cat.No.	Number of blades in a case	QTY/ Inner carton	QTY/ Outer carton	N.W. (kgs)	G.W. (kgs)	M3	Carton size (Cm) D x W x H	EAN	Stock available in Rotterdam
GB-10W EVO	10	20	200	19	21	0.014	24 x 36 x 15.5	4954183 524753	○
GB-50W EVO	50	10	50	21	23	0.011	15 x 45 x 16.5	4954183 524760	×

### OIL FREE Blades

**NEW** **EVO** DURABLE EDGE

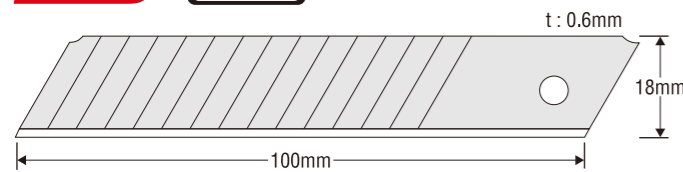

Cat.No.	Number of blades in a case	QTY/ Inner carton	QTY/ Outer carton	N.W. (kgs)	G.W. (kgs)	M3	Carton size (Cm) D x W x H	EAN	Stock available in Rotterdam
GB-50WOF EVO	50	10	50	21	23	0.011	15 x 45 x 16.5	4954183 563936	×

## Spare Blades

### L-Blades 18 mm

**EVO** SHARP EDGE

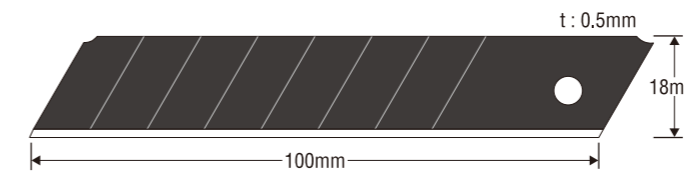

Cat.No.	Number of blades in a case	QTY/ Inner carton	QTY/ Outer carton	N.W. (kgs)	G.W. (kgs)	M3	Carton size (Cm) D x W x H	EAN	Stock available in Rotterdam
★LB-10B EVO	10	20	200	15	17	0.014	24 x 36 x 15.5	4954183 528409	○
★LB-50B EVO	50	10	50	19	21	0.011	15 x 45 x 16.5	4954183 528416	○

**EVO** DURABLE EDGE

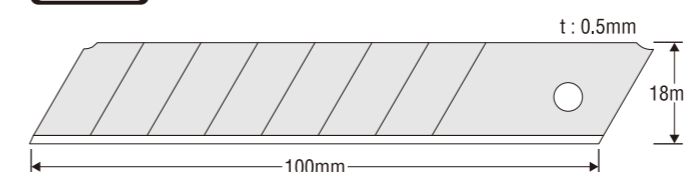

Cat.No.	Number of blades in a case	QTY/ Inner carton	QTY/ Outer carton	N.W. (kgs)	G.W. (kgs)	M3	Carton size (Cm) D x W x H	EAN	Stock available in Rotterdam
★LB-10 EVO	10	20	200	15	17	0.014	24 x 36 x 15.5	4954183 528423	○
★LB-50 EVO	50	10	50	19	21	0.011	15 x 45 x 16.5	4954183 528430	○

### 15 segments Blades

**EVO** SHARP EDGE

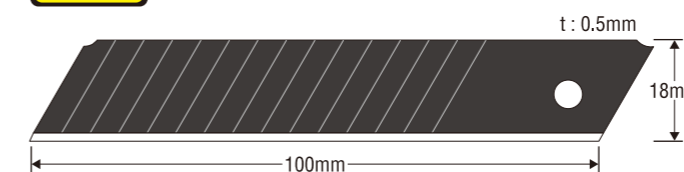

Cat.No.	Number of blades in a case	QTY/ Inner carton	QTY/ Outer carton	N.W. (kgs)	G.W. (kgs)	M3	Carton size (Cm) D x W x H	EAN	Stock available in Rotterdam
LB-10BW EVO	10	20	200	15	17	0.014	24 x 36 x 15.5	4954183 528294	×

**EVO** DURABLE EDGE

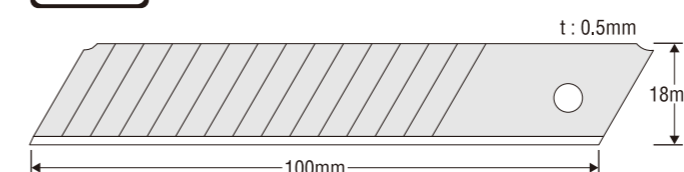

Cat.No.	Number of blades in a case	QTY/ Inner carton	QTY/ Outer carton	N.W. (kgs)	G.W. (kgs)	M3	Carton size (Cm) D x W x H	EAN	Stock available in Rotterdam
LB-10W EVO	10	20	200	15	17	0.014	24 x 36 x 15.5	4954183 528287	○
LB-50W EVO	50	10	50	19	21	0.011	15 x 45 x 16.5	4954183 528805	×



## Spare Blades

### L-Blades 18mm

#### Non-Snap Blades

Solid blades, non-snap blades for special purpose

#### EVO SHARP EDGE

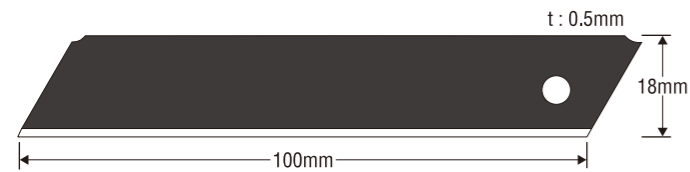

Cat.No.	Number of blades in a case	QTY/ Inner carton	QTY/ Outer carton	N.W. (kgs)	G.W. (kgs)	M3	Carton size (Cm) D x W x H	EAN	Stock available in Rotterdam
★LB-10BNL EVO	10	20	200	15	17	0.014	24 x 36 x 15.5	4954183 524678	×
LB-50BNL EVO	50	10	50	19	21	0.011	15 x 45 x 16.5	4954183 524685	×

#### EVO DURABLE EDGE

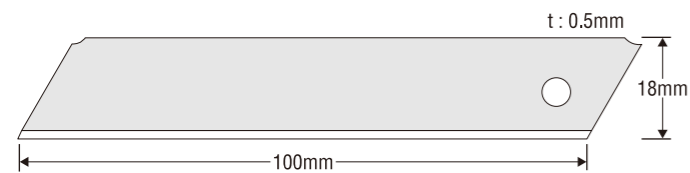

Cat.No.	Number of blades in a case	QTY/ Inner carton	QTY/ Outer carton	N.W. (kgs)	G.W. (kgs)	M3	Carton size (Cm) D x W x H	EAN	Stock available in Rotterdam
LB-10NL EVO	10	20	200	15	17	0.014	24 x 36 x 15.5	4954183 524692	×
LB-50NL EVO	50	10	50	19	21	0.011	15 x 45 x 16.5	4954183 524708	×

## Stainless steel Series Perfect for wet environments

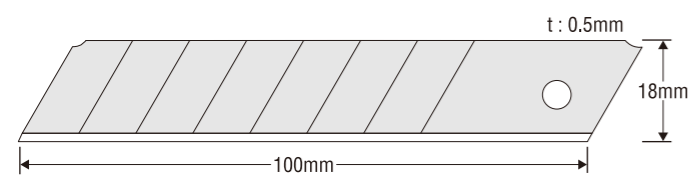

LB-10S EVO



Stainless steel blade

Cat.No.	Number of blades in a case	QTY/ Inner carton	QTY/ Outer carton	N.W. (kgs)	G.W. (kgs)	M3	Carton size (Cm) D x W x H	EAN	Stock available in Rotterdam
LB-10S EVO	10	20	200	15	17	0.014	24 x 36 x 15.5	4954183 564049	×

## Spare Blades

### S-Blades 9mm

#### EVO SHARP EDGE

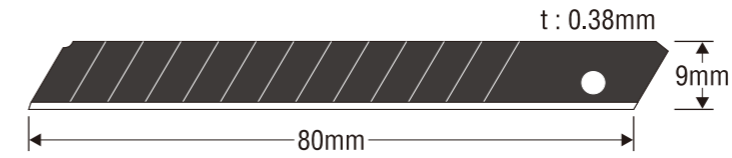

Cat.No.	Number of blades in a case	QTY/ Inner carton	QTY/ Outer carton	N.W. (kgs)	G.W. (kgs)	M3	Carton size (Cm) D x W x H	EAN	Stock available in Rotterdam
SB-10B EVO	10	20	200	5	7	0.007	16 x 31 x 14	4954183 524838	○
★SB-50B EVO	50	10	50	18	20	0.004	9 x 33.5 x 13	4954183 524845	○

#### EVO DURABLE EDGE

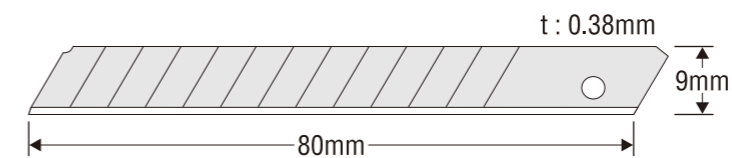

Cat.No.	Number of blades in a case	QTY/ Inner carton	QTY/ Outer carton	N.W. (kgs)	G.W. (kgs)	M3	Carton size (Cm) D x W x H	EAN	Stock available in Rotterdam
★SB-10 EVO	10	20	200	5	7	0.007	16 x 31 x 14	4954183 524852	○
SB-50 EVO	50	10	50	18	20	0.004	9 x 33.5 x 13	4954183 524869	×

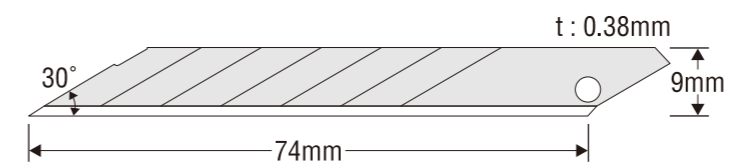

VB-10 EVO

Application : S-18

Cat.No.	Number of blades in a case	QTY/ Inner carton	QTY/ Outer carton	N.W. (kgs)	G.W. (kgs)	M3	Carton size (Cm) D x W x H	EAN	Stock available in Rotterdam
★VB-10 EVO	10	20	200	7	9	0.007	16 x 31 x 14	4954183 528478	○

# Spare Blades

## S-Blades 9mm

**Non-Snap Blades** Solid blades, non-snap blades for special purpose

### **EVO** SHARP EDGE



Cat.No.	Number of blades in a case	QTY/ Inner carton	QTY/ Outer carton	N.W. (kgs)	G.W. (kgs)	M3	Carton size (Cm) D x W x H	EAN	Stock available in Rotterdam
SB-10BNL EVO	10	20	200	5	7	0.007	16 x 31 x 14	4954183 528300	×
SB-50BNL EVO	50	10	50	18	20	0.004	9 x 33.5 x 13	4954183 528317	×

### **EVO** DURABLE EDGE



Cat.No.	Number of blades in a case	QTY/ Inner carton	QTY/ Outer carton	N.W. (kgs)	G.W. (kgs)	M3	Carton size (Cm) D x W x H	EAN	Stock available in Rotterdam
SB-10NL EVO	10	20	200	5	7	0.007	16 x 31 x 14	4954183 528485	×
SB-50NL EVO	50	10	50	18	20	0.004	9 x 33.5 x 13	4954183 530129	×

## Saws

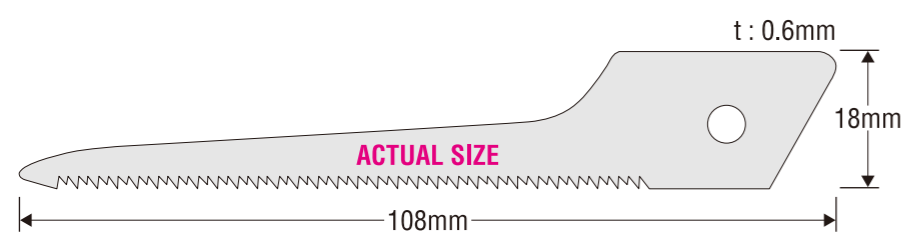

Application : T-11 T-16 T-17

Cat.No.	Number of blades in a case	QTY/ Inner carton	QTY/ Outer carton	N.W. (kgs)	G.W. (kgs)	M3	Carton size (Cm) D x W x H	EAN	Stock available in Rotterdam
HSB-W	1	10	100	3	4	0.022	33 x 36 x 18.5	4954183 516826	×

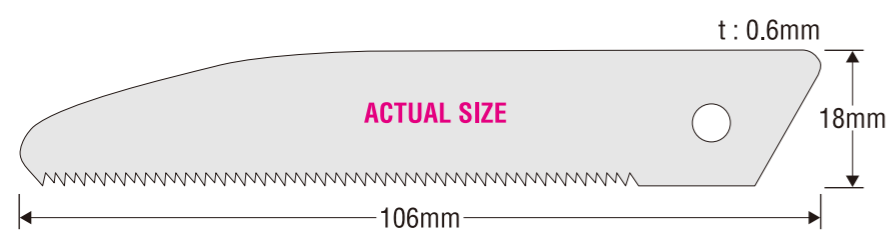

Application : T-11 T-16 T-17

Cat.No.	Number of blades in a case	QTY/ Inner carton	QTY/ Outer carton	N.W. (kgs)	G.W. (kgs)	M3	Carton size (Cm) D x W x H	EAN	Stock available in Rotterdam
HSB-Z	1	10	100	3	4	0.022	33 x 36 x 18.5	4954183 516819	×

# Spare Blades

## Hook

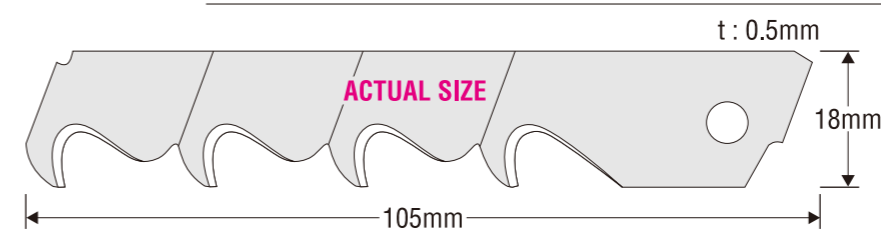

Application : HK-11 HK-12

Made in Solingen, Germany

HK-5 EVO

Cat.No.	Number of blades in a case	QTY/ Inner carton	QTY/ Outer carton	N.W. (kgs)	G.W. (kgs)	M3	Carton size (Cm) D x W x H	EAN	Stock available in Rotterdam
★ HK-5 EVO	5	20	200	11	13	0.014	24 x 36 x 15.5	4954183 524777	×

## Spare blades for Rotary



Application : RT-28, RT-45, RT-60

Cat.No.	Number of blades in a case	QTY/ Inner carton	QTY/ Outer carton	N.W. (kgs)	G.W. (kgs)	M3	Carton size (Cm) D x W x H	EAN	Stock available in Rotterdam
RTB-28	2	50	300	3.5	4.0	0.020	38 x 19.5 x 26	4954183 562786	○
RTB-45	1	50	300	3.5	4.5	0.021	36 x 25 x 23	4954183 524654	○
RTB-60	1	50	300	3.5	4.5	0.021	36 x 25 x 23	4954183 562809	○

## Others

DB-48

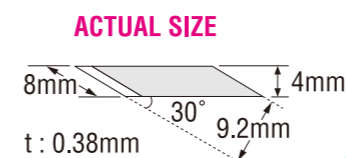

Application : D-12

PB-10

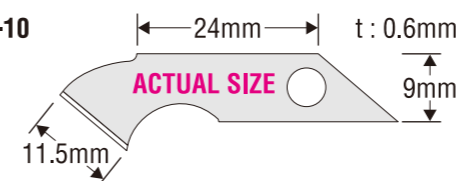

Application : P-11

PB-10A

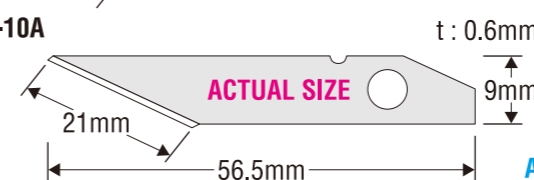

Application : P-11



Cat.No.	Number of blades in a case	QTY/ Inner carton	QTY/ Outer carton	N.W. (kgs)	G.W. (kgs)	M3	Carton size (Cm) D x W x H	EAN	Stock available in Rotterdam
DB-48	48	10	100	8	10	0.022	33 x 36 x 18.5	4954183 542832	×
PB-10	10	10	100	4	6	0.022	33 x 36 x 18.5	4954183 542818	×
PB-10A	10	10	100	4	6	0.022	33 x 36 x 18.5	4954183 542825	×



# KDS® The Pro's Quality Choice

Spare Blades

## Power Black Evolution



## Power White Evolution



## Trapezoidal series



## Others



## Non-Snap series



## 15 segments series



## Stainless steel series



## Oil Free series



# Spare Blades packaging

No.	Cat.No.	Number of blades in a case	QTY/Inner carton 	QTY/Outer carton 		
<b>25mm</b>						
1	HB-5B EVO	5		10		
2	HB-10B EVO	10				Packed 10 inner cartons
3	HB-10 EVO					
4	HB-10BNL EVO					
5	HB-10NL EVO					
<b>G-18mm</b>						
6	GB-10B EVO	10		20		
7	GB-10 EVO					
8	GB-10W EVO					
9	GB-50B EVO	50		10		
10	GB-50 EVO					
11	GB-50WOF EVO					
<b>18mm</b>						
12	LB-10B EVO	10		20		
13	LB-10 EVO					
14	LB-10BW EVO					
15	LB-10W EVO					
16	LB-10BNL EVO					
17	LB-10NL EVO					
18	LB-10S EVO					
19	HK-5 EVO				5	
20	LB-50B EVO	50		10		
21	LB-50 EVO					
22	LB-50W EVO					
23	LB-50BNL EVO					
24	LB-50NL EVO					
<b>9mm</b>						
25	SB-10B EVO	10		20		
26	SB-10 EVO					
27	VB-10 EVO					
28	SB-10BNL EVO	50		10		
29	SB-10NL EVO					
30	SB-50B EVO					
31	SB-50 EVO	50		10		
32	SB-50BNL EVO					
33	SB-50NL EVO					
<b>Saws</b>						
34	HSB-W	1		10		
35	HSB-Z					
<b>Trapezoidal series</b>						
36	TB-5B	5		20		
37	TB-50B	50		8		
<b>Others</b>						
38	DB-48	48		10		
39	PB-10	10			Packed 10 inner cartons	100
40	PB-10A					

Spare Blades

# Safety-Bases

## Safety-Bases E

Concern for our planet  
Non-toxic if incinerated.  
Made of Olefin resin.

From easy-to-use day-timer size to large desk size, choose the one that's best for you.

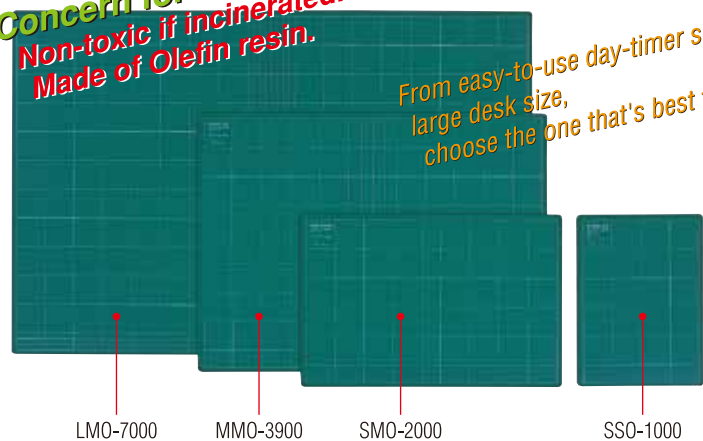

Takes an edge softly, keeps the media from slipping, protects your desk or table from scratches, and makes cutting safe.

### Three environmental-E!!

Use both sides! Lasts twice as long!  
Made of Olefin resin. Rigid and lightweight.  
Efficient, 5mm grid lines.

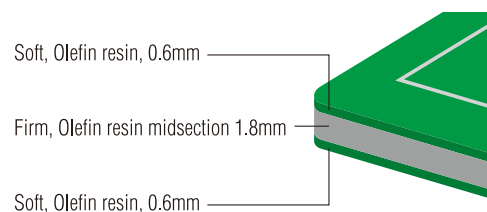

Cat.No.	Size(mm)	QTY/ Inner carton	QTY/ Outer carton	N.W. (kgs)	G.W. (kgs)	M3	Stock available in Rotterdam
<b>Easy-eye Green</b>							
SSO-1000	300 x 220 x 3	10	80	24	26	0.045	X
SMO-2000	450 x 300 x 3		40				
MMO-3900	620 x 450 x 3	20	23	25	0.085		
LMO-7000	600 x 900 x 3	10				0.045	

## Safety-Bases

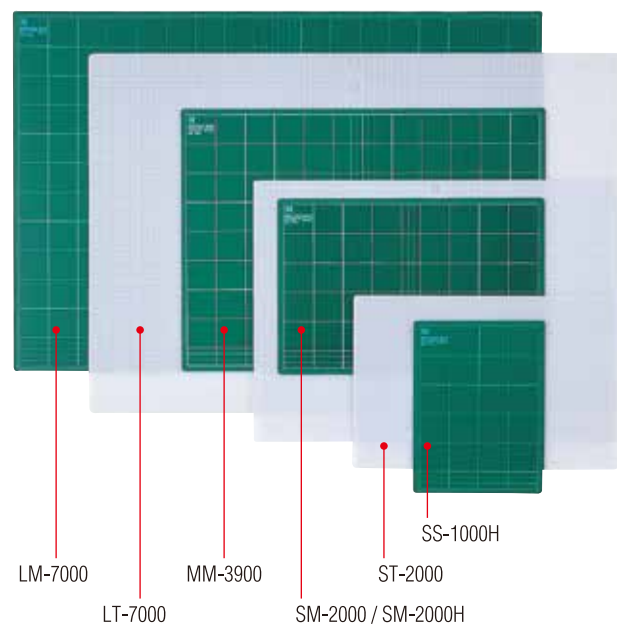

No matter how many times it's cut, slices don't stand-out or expand.  
One-coat adhesive tapes (double-sided tape, etc.) come up easily.  
Use both sides : soft on front and back (no grid lines on back)  
The translucent mat is perfect for safe tracing and cutting on light tables.  
When stored flat, the layered construction of the Safety Base resists bending, warping, delaminating, or cracking.

Cat.No.	TYPE	Size(mm)	QTY/ Inner carton	QTY/ Outer carton	N.W. (kgs)	G.W. (kgs)	M3	Stock available in Rotterdam	
<b>Easy-eye Green</b>									
SS-1000H	Hard type	300 x 220 x 3	10	80	24	26	0.045	X	
SM-2000H		450 x 300 x 3		40				X	
SM-2000	Soft type	450 x 300 x 3	10	20	23	25	0.085	X	
MM-3900		620 x 450 x 3		10				0.045	X
LM-7000		900 x 620 x 3		5				0.030	X
CM-80x120G		800 x 1200 x 3	5	22	24	27		X	
CM-100x150G		1000 x 1500 x 3	5	25	27			X	
<b>Translucent</b>									
ST-2000	Soft type	450 x 300 x 3	10	40	23	25	0.045	X	
LT-7000		900 x 620 x 3		10				X	

Layered construction  
Soft type



Hard type



Soft PVC 1.0mm  
Hard PVC 1.0mm  
Soft PVC 1.0mm  
Thickness 3.0mm

Soft PVC 1.0mm  
Hard PVC 2.0mm  
Thickness 3.0mm

# Sickle

## BK-11 Banana sickle



The Banana Sickle is recommended for multi-purpose use, i.e. for flooring, agriculture, roofing, etc, etc. High carbon steel blade.



Cat.No.	Color	Handle Length	QTY/ Inner carton	QTY/ Outer carton	N.W. (kgs)	G.W. (kgs)	M3	"Carton size (cm) D x W x H"	EAN	Stock available in Rotterdam
★BK-11	Yellow	120mm	6	144	14	16	0.062	30 x 64 x 32	4954183 562847	X

# Scissors

## Stainless Steel Scissors



KSC-1

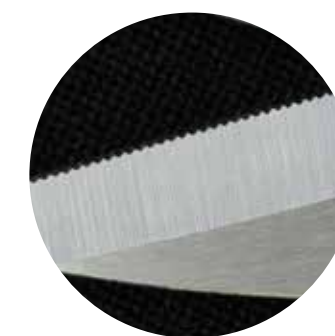

Recommended for professionals as well as DIY users.  
Stainless steel blades and secure hinge for heavy-duty tasks.  
Non-slip serrated blades assure safe and smooth cutting.



KSC-2



Carton

Box



KSC-1

KSC-2

Cat.No.	Color	Size	QTY/ Inner carton	QTY/ Outer carton	N.W. (kgs)	G.W. (kgs)	M3	"Carton size (cm) D x W x H"	EAN	Stock available in Rotterdam
★KSC-1	Yellow	5-1/2" 140mm	12	96	7	9	0.027	26 x 43 x 24	4954183 561901	○
★KSC-2		6-1/2" 165mm			8	10				4954183 527761



# GG Scraper



Recommended for removal of various materials, including wallpaper and tile, paint, gaskets, adhesives, and floor coverings.

- 1) Fluoroplastic-coated head prevents sticking and allows for easy cleaning.
- 2) No need for screwdrivers or coins, the thumb-locking screws keep the blade tight.
- 3) Three length to suit the specific job.



Come with 5 non-snap blades

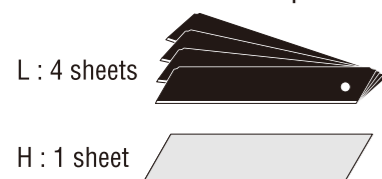

The H-type blades is 40% thicker and 38% wider than L-type blades for heavy duty task.

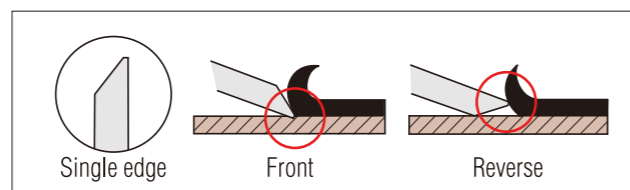
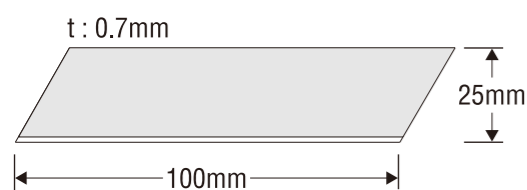

\* H-type is dedicated blades for GG Scraper series.

Cat. No.	Description	Size	QTY/ Inner carton	QTY/ Outer carton	N.W. (kgs)	G.W. (kgs)	M3	Carton size (Cm) D x W x H	EAN	Stock available in Rotterdam
★ SCL-200BC	Come with a BLADE COVER and 5 non-snap blades	200mm	4	24	10	12	0.058	56 x 34 x 30	4954183 525538	○
★ SCL-300BC		300mm			13	15	0.070	56 x 43 x 30	4954183 525545	○
★ SCL-600BC		600mm			15	17	0.124	74 x 57 x 30	4954183 525552	○
SCL-1200BC		1200mm			16	18	0.180	38 x 137 x 34	4954183 532123	○
LB-10BNL EVO	10 blades in a pla. case	L-type (t:0.5mm)	20	200	15	17	0.014	24 x 36 x 15.5	4954183 524678	×
★ HB-5SCL	5 blades in a pla. case	H-type (t:0.7mm)	20	100	8	10	0.011	15 x 45 x 16.5	4954183 528133	×

HB-5SCL

# Stainless steel putty knives



Co-mold non-slip rubber grip and 4 screw bits in the handle. Hardened and tempered stainless steel blade.

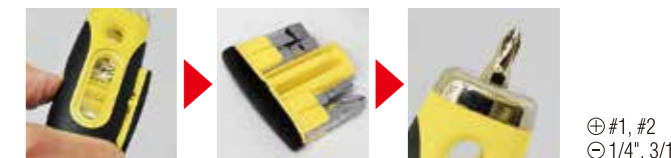

## Flexible type



## Chisel type



## 14-in-1 type



	Cat.No.	Type	Width	QTY/ Inner carton	QTY/ Outer carton	N.W. (kgs)	G.W. (kgs)	M3	Carton size (Cm) D x W x H	EAN	Stock available in Rotterdam	
①	★ SC-F76SD	Flexible	3" / 76mm	12	72	10	12	0.034	27 x 59 x 21	4954183 525170	×	
②	★ SC-F102SD		4" / 102mm			11	13			4954183 525187	×	
③	★ SC-F127SD		5" / 127mm			12	14			4954183 525194	×	
④	★ SC-F152SD		6" / 152mm			12	14			4954183 525200	×	
⑤	★ SC-C38SD	Chisel	1-1/2" / 38mm			10	12	0.034	27 x 59 x 21	4954183 525132	×	
⑥	SC-C51SD		2" / 51mm			-	×					
⑦	SC-C76SD		3" / 76mm			11	13			4954183 530181	×	
⑧	SC-M76SD	Chisel 14-in-1	3" / 76mm			144	17	22	0.065	37 x 76 x 25	4954183 530174	×
⑨	★ SC-M35	Fold out 14-in-1	1-1/2" / 38mm								4954183 525149	×



# GG saw

**NEW** **GG SAW** ~ Ideal for cutting PVC & WOOD ~

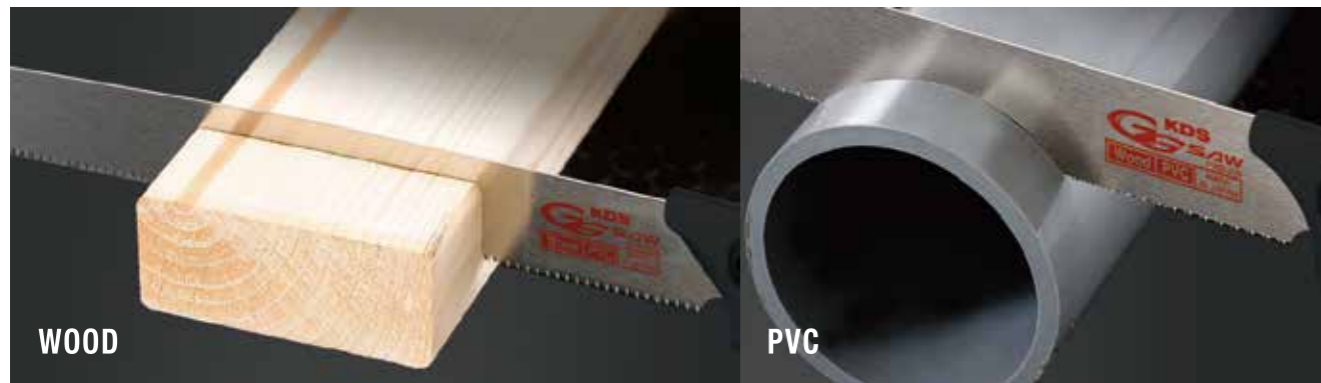

### Maximum cutting size

PVC/PE pipe	100mm $\phi$
Plastic plate	t: 10mm
Wood	t: 50mm

### Specifications

Metal	SK95 (SK4) High carbon steel
Blade length	235mm
Thickness	0.7mm
TPI (Teeth Per Inch)	20
Kerf	1.0mm ( $\pm 0.05$ mm)

Cat.No.	QTY/ Inner carton	QTY/ Outer carton	N.W. (kgs)	G.W. (kgs)	M3	Carton size (Cm) D x W x H	EAN	Stock available in Rotterdam
PW-235	10	60	9	10	0.030	39 x 44 x 17	4954183 531119	○
PWB-235	10	150	11	12	0.020	35 x 28 x 20	4954183 531126	○

# CLAMPS

## Metal Handy Clamp



Aluminum pressure adjusting power clamp. Cushioned jaw heads with auto bounce-back action when tightened.

Cat.No.	Capacity	QTY/ Box	QTY/ Carton	N.W. (kgs)	G.W. (kgs)	M3	"Carton size (cm) D x W x H"	EAN	Stock available in Rotterdam
MHC-76	75mm	12	48	15	17	0.051	32 x 44 x 36	-	×



## Metal Bar Clamp



Bar Clamp & Spreader with aluminum alloy body and steel, forged parts. Buffered jaw head with auto bounce-back action when tightened.

Carbon steel bar. Jaw depth of 85mm with pads. Quick release trigger on the handle. Clamping force up to 350kg / 770lbs

Cat.No.	Capacity	QTY/ Inner carton	QTY/ Outer carton	N.W. (kgs)	G.W. (kgs)	M3	"Carton size (cm) D x W x H"	EAN	Stock available in Rotterdam
★ MBC-150	150mm	6	12	11	13	0.026	39 x 26 x 26	4954183 539429	×
★ MBC-300	300mm			12	14	0.037	54 x 26 x 26	4954183 539436	×
★ MBC-450	450mm			7	8	0.020	68 x 24 x 12	4954183 539450	×
★ MBC-600	600mm	4	12	8	9	0.024	83 x 24 x 12	4954183 539481	×
★ MBC-1200	1200mm			21	23	0.105	150 x 26 x 27	4954183 539498	×



## Metal Hold Down Clamp



Cat.No.	Capacity	QTY/ Inner carton	QTY/ Outer carton	N.W. (kgs)	G.W. (kgs)	M3	"Carton size (cm) D x W x H"	EAN	Stock available in Rotterdam
★ MWB-150	150mm	6	12	11	13	0.020	45 x 28 x 16	4954183 539511	×
★ MWB-300	300mm			13	15	0.027	60 x 28 x 16	4954183 539528	×
★ MWB-450	450mm			8	9	0.014	75 x 13 x 14	4954183 539535	×
★ MWB-600	600mm	12	12	9	11	0.016	89 x 13 x 14	4954183 539542	×
★ MF-01	2 Stands for MWB series			2	3	-	-	4954183 530570	×

Hold Down Clamp & Vise with aluminum alloy body and steel forging parts. Carbon steel bar. Jaw depth of 85mm with pads. Lever handle for easy release. Clamping force up to 300kg / 660lbs



MF-01

## Metal Pipe Clamp



Professional Heavy Duty Pipe Clamp & Spreader with aluminum alloy body and steel, forged parts. Pipe is not part of the product. ( fits  $\phi 27.2$ mm, 3/4 inch). Clamping force up to 1,000kg.

Cat.No.	Description	QTY/ Inner carton	QTY/ Outer carton	N.W. (kgs)	G.W. (kgs)	M3	"Carton size (cm) D x W x H"	EAN	Stock available in Rotterdam
PC-01	Fits $\phi 27.2$ mm, 3/4 inch	6	12	14	16	0.039	29 x 51 x 26	-	×
FP-01	Stands for PC-01	12		3	4	-	-	-	×



Clamps

Saw



# Pocket Tapes



## **NEW** New pocket tape series is debut !!

Thick hook : 1.5 times more thick than the KDS standard hook.  
 Thick tape: New solid tape blade for more stand out than KDS "ZS series".  
 New gum cover for more fitting to the Human palm.

**Nylon coated blade\***  
**5 times more durable** than  
 KDS original acrylic coating

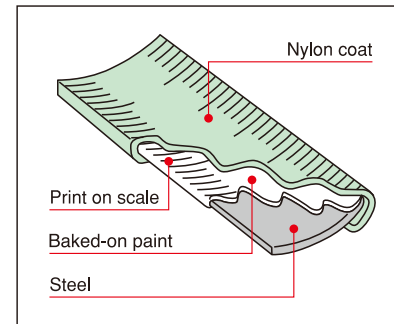
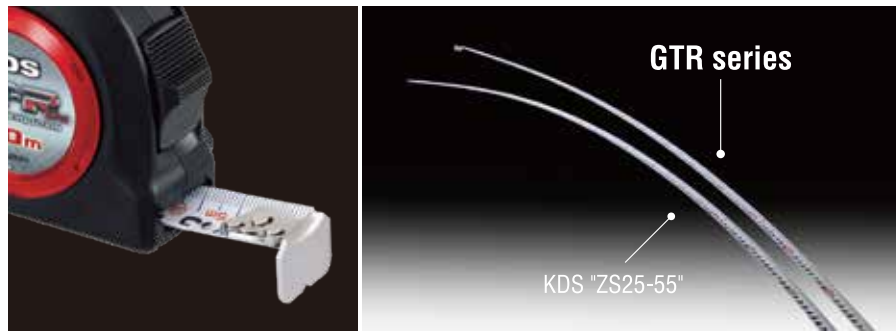

**GT-R with Holder**



Cat.No.	Length	Width	QTY/ Inner carton	QTY/ Outer carton
GTR-2550	5m	25mm	4	40
GTR-G2550				
GTR-G2550Z				

# Coatings

## **DURA COAT** DURA COAT

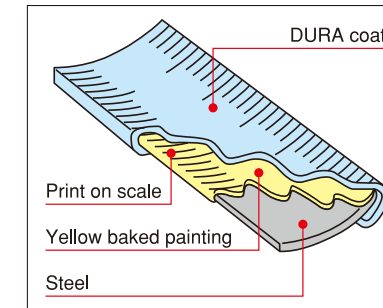

**10 times** more durable than Acrylic coating but case size as compact as Acrylic.

## **Nylon Coat**

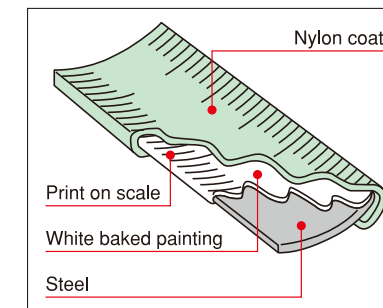

**5 times** more durable than Acrylic coating but case size as compact as Acrylic.

## **KDS** KDS Standard

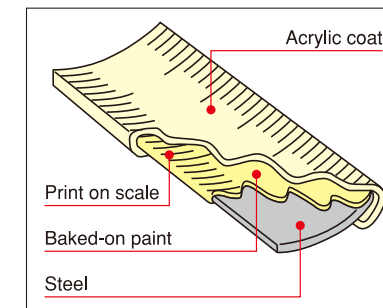

## **Double-faced scale** Double-faced scale

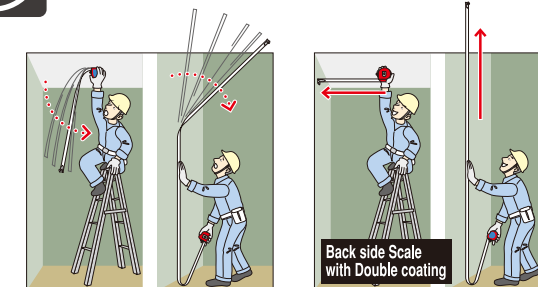

## **4rivets** Strong 4rivets

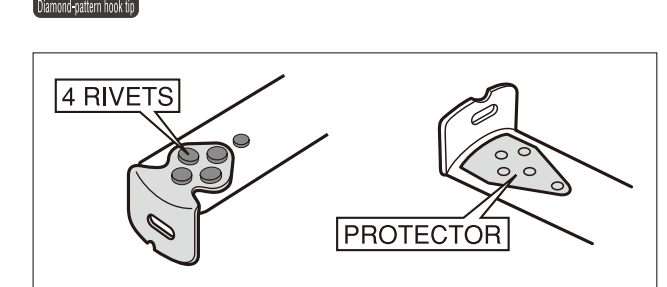



# Pocket Tapes Double-faced Scale



## New ergonomic design case



## Short-Stroke Slider



Shortened about 6mm

## Nylon coated blade\*

5 times more durable than KDS original acrylic coating

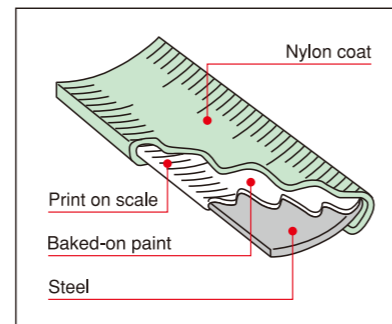

\* Except GGEVO25-10 series

## Scales on Front and Back



## New elastomer damper

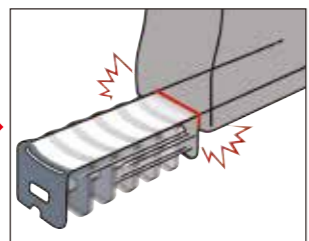
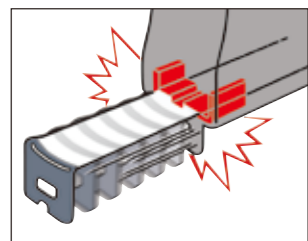

## 4-Rivet, Diamond-Pattern Tip and protector

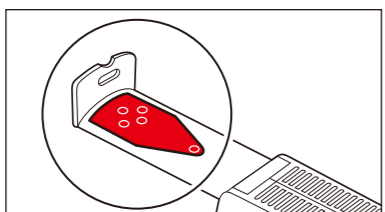
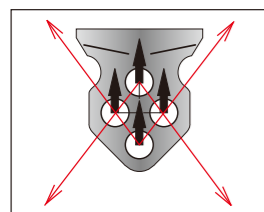

# Pocket Tapes Double-faced Scale



## GGEVO 19



New ergonomic design case. The nylon-coated blade is **5 times more durable** than KDS original acrylic coating. Non-slip rubberized grip fits your palm and protects the case from damage. Hook protector protects end-hook. The tape itself has scales on both sides to easily measure heights, and comes with a strong, 4-rivet diamond-pattern hook.



	Cat.No.	Length	Width	QTY/ Inner carton	QTY/ Outer carton	N.W. (kgs)	G.W. (kgs)	M3	"Carton size (cm) D x W x H"	Stock available in Rotterdam
EU	GGEVO19-55EU	5.5m	19mm	4	40	12	14	0.045	22 x 65 x 32	○
ME	GGEVO19-55ME	5.5m x 18ft.								×



## GGEVO 25



New ergonomic design case. The nylon-coated blade is **5 times more durable** than KDS original acrylic coating.\* Non-slip rubberized grip fits your palm and protects the case from damage. Hook protector protects end-hook. The tape itself has scales on both sides to easily measure heights, and comes with a strong, 4-rivet diamond-pattern hook.

\*Except GGEVO25-10 series.

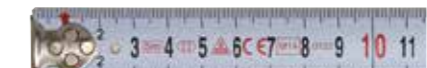

	Cat.No.	Length	Width	QTY/ Inner carton	QTY/ Outer carton	N.W. (kgs)	G.W. (kgs)	M3	"Carton size (cm) D x W x H"	Stock available in Rotterdam	
EU	GGEVO25-55EU	5.5m	25mm	4	40	16	18	0.045	22 x 65 x 32	○	
	GGEVO25-75EU	7.5m				20	22		0.050	24 x 65 x 32	○
	GGEVO25-10EU	10m				24	26		○		
ME	GGEVO25-55ME	5.5m x 18ft	25mm	4	40	16	18	0.045	22 x 65 x 32	×	
	GGEVO25-75ME	7.5m x 25ft				20	22		×		
	★GGEVO25-10ME	10m x 33ft				24	26		0.050	24 x 65 x 32	×
E (inch)	GGEVO25-75E	25ft				20	22		24 x 65 x 32	×	



# Pocket Tapes Double-faced Scale

## GGEVO 25 Drop Protection

Drop protection tape with locking belt clip and lanyard.



Magnetic end-hook



With a Slot-in tape holder



	Cat.No.	Length	Width	QTY/ Inner carton	QTY/ Outer carton	N.W. (kgs)	G.W. (kgs)	M3	"Carton size (cm) D x W x H"	Stock available in Rotterdam
ME	GGEVO25-55WME AR	5.5m x 18ft	25mm	4	40	16	17	0.060	64 x 30 x 32	×
	GGEVO25-75WME AR	7.5m x 25ft				20	22			×
E (inch)	GGEVO25-75WE AR	25ft				20	22			×

## Escargots

**Go Retro!** Go back in KDS history to 1936 when we imported small pocket tapes from Germany. Renewed with modern technology, the Escargot combines simple functionality with timeless style.



News paper advertisement in 1936



Cat.No.	Length	Width	QTY/Box	QTY/Carton	N.W. (kgs)	G.W. (kgs)	M3	"Carton size (cm) D x W x H"	Stock available in Rotterdam
RSB-2BP	2m	16mm	6	60	4	5	0.024	34 x 49 x 15	×

# Pocket Tapes Double-faced Scale

## NEO DURA SERIES PRO DURA SERIES

### Best balance for "Durability" and "Thinness"

**DURA COAT** is developed from New technology of polyester extrusion coating for tapes. Graduation is heart of Pocket tapes, **DURA COAT** is **10 times** more durable than our standard coating.

**NEO DURA SERIES** and **PRO DURA SERIES** has scales on both sides. It makes easily to measure the heights. Come with patent pending, \*4-rivet diamond-pattern hook. (\*19&25 mm width) It is KDS's 80 years' pride with the tapes.



### Eraser Test

Objective :To test the durability of coating on measuring tape

- Testing Method :
- Step 1 Setting up Sand Eraser at 90 degree
  - Step 2 4kgs of weight is loaded on the eraser
  - Step 3 Revolves under the eraser

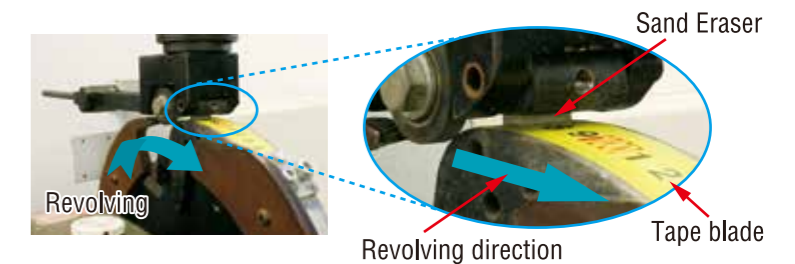

### TEST RESULT

Based on our internal test

" **DURA COAT** is 10 times Longer Usage "

Normal Coat		KDS		Brand A		KDS		Brand A		KDS		Brand A	
after 100 times	after 100 times	after 350 times	after 350 times	after 1000 times	after 1000 times	after 1000 times	after 1000 times	after 1000 times	after 1000 times	after 1000 times	after 1000 times	after 1000 times	after 1000 times
DURA COAT		KDS		Brand B		KDS		Brand B		KDS		Brand B	
after 100 times	after 100 times	after 350 times	after 350 times	after 1000 times	after 1000 times	after 1000 times	after 1000 times	after 1000 times	after 1000 times	after 1000 times	after 1000 times	after 1000 times	after 1000 times



# Pocket Tapes Double-faced Scale

## NEO DURA SERIES

**10 times Durability** compare with KDS conventional coating



Hook protector      Fit in your palm

### NEO DURA-G (Gum)



Non-slip rubberized grip fits in your palm and protect case from damages. Both-sides print scale with Dura Coating technologies. Soon to be your favorite tape. Featuring a unique KDS Double-lock system, pulling up on the lock tab for easy brake, while pushing down engages the full lock.



	Cat.No.	Length	Width	QTY/ Inner carton	QTY/ Outer carton	N.W. (kgs)	G.W. (kgs)	M3	"Carton size (cm) D x W x H"	Stock available in Rotterdam
EU	DVG19-30EU	3m	19mm	4	40	8	10	0.030	20 x 64 x 23	○
	DVG19-50EU	5m				10	12			○
	DVG25-50EU		25mm			13	15			○
ME	DVG19-35ME	3.5m x 12ft	19mm	4	40	8	10	0.030	20 x 64 x 23	×
	DVG19-55ME	5.5m x 18ft				10	12			×
	DVG25-50ME	5m x 16ft	13			15	×			
	★DVG25-75ME	7.5m x 25ft	25mm			18	20			×
E (inch)	★DVG25-75E	25ft								×

※ME graduation series come with different Plate label design



### NEO DURA-M (Metal)



Fashionable and stylish outlook. Featuring a unique KDS Double-lock system, pulling up on the lock tab for easy brake, while pushing down engages the full lock.



	Cat.No.	Length	Width	QTY/ Inner carton	QTY/ Outer carton	N.W. (kgs)	G.W. (kgs)	M3	"Carton size (cm) D x W x H"	Stock available in Rotterdam
EU	DVZ19-30EU	3m	19mm	6	60	10	12	0.035	34 x 57 x 18	○
	DVZ19-50EU	5m				12	14			×
	DVZ25-50EU		25mm			18	20			×
	★DVZ25-80EU	8m	25mm	4	40	19	21	0.030	23 x 63 x 21	×

# Pocket Tapes Double-faced Scale

## PRO DURA SERIES

**10 times Durability** compare with KDS conventional coating

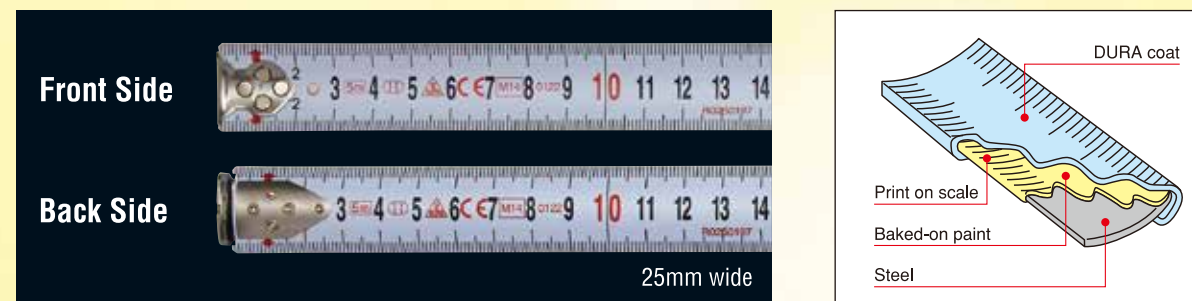

### PRO DURA 16

Compact size pocket tape with Dura Coating technologies.



	Cat.No.	Length	Width	QTY/ Inner carton	QTY/ Outer carton	N.W. (kgs)	G.W. (kgs)	M3	"Carton size (cm) D x W x H"	Stock available in Rotterdam
EU	PDX16-30EU	3m	16mm	6	60	9	11	0.035	34 x 57 x 18	○
	PDX16-50EU	5m				10	12			×
ME	PDX16-35ME	3.5m x 12ft.	16mm	6	60	9	11	0.035	34 x 57 x 18	×
	PDX16-55ME	5.5m x 18ft.				10	12			×

### PRO DURA 19/25

Popular size pocket tape with Dura Coating technologies. Featuring a unique KDS Double-lock system, pulling up on the lock tab for easy brake, while pushing down engages the full lock.



	Cat.No.	Length	Width	QTY/ Inner carton	QTY/ Outer carton	N.W. (kgs)	G.W. (kgs)	M3	"Carton size (cm) D x W x H"	Stock available in Rotterdam
EU	PDX19-50EU	5m	19mm	6	60	12	14	0.035	34 x 57 x 18	○
	PDX25-50EU		25mm			18	20			○
	PDX25-75EU					7.5m	25			27
ME	PDX19-55ME	5.5m x 18ft.	19mm	6	60	12	14	0.035	34 x 57 x 18	×
	PDX25-50ME	5.0m x 16ft.	25mm			18	20			×
	PDX25-75ME	7.5m x 25ft.				25	27			×
E (inch)	PDX25-75E	25ft.								×



# Pocket Tapes Double-faced Scale

## Both side Print 19



The KDS **Double-lock** leads the way in measuring tape development. Featuring a unique double-lock system, **pulling up** on the locking tab applies an easy rewind brake, while **pushing down** engages the full lock. The round design fits nicely in the palm. The tape itself has scales on both side to easily measure heights, and comes with a strong, diamond-pattern hook.

**4-rivet diamond-pattern hook.**

	Cat.No.	Length	Width	QTY/ Inner carton	QTY/ Outer carton	N.W. (kgs)	G.W. (kgs)	M3	"Carton size (cm) D x W x H"	Stock available in Rotterdam
EU	ZS19-50EU	5m	19mm	6	60	13	15	0.035	20 x 61 x 29	×
	ZS19-70EU	7m				18	20			×



## Both side Print 22



The KDS **Double-lock** leads the way in measuring tape development. Featuring a unique double-lock system, **pulling up** on the locking tab applies an easy rewind brake, while **pushing down** engages the full lock. The round design fits nicely in the palm. The tape itself has scales on both side to easily measure heights, and comes with a strong, diamond-pattern hook.

**4-rivet diamond-pattern hook.**

	Cat.No.	Length	Width	QTY/ Inner carton	QTY/ Outer carton	N.W. (kgs)	G.W. (kgs)	M3	"Carton size (cm) D x W x H"	Stock available in Rotterdam
EU	ZS22-50EU	5m	22mm	6	60	15	17	0.035	20 x 61 x 29	×



## Both side Print 25



The KDS **Double-lock** leads the way in measuring tape development. Featuring a unique double-lock system, **pulling up** on the locking tab applies an easy rewind brake, while **pushing down** engages the full lock. The round design fits nicely in the palm. The tape itself has scales on both side to easily measure heights, and comes with a strong, diamond-pattern hook.

**4-rivet diamond-pattern hook.**

	Cat.No.	Length	Width	QTY/ Inner carton	QTY/ Outer carton	N.W. (kgs)	G.W. (kgs)	M3	"Carton size (cm) D x W x H"	Stock available in Rotterdam
EU	ZS25-50EU	5m	25mm	4	40	11	13	0.035	20 x 61 x 29	×
	ZS25-80EU	8m				16	18			○
	ZS25-10EU	10m				22	24	○		



# Pocket Tapes Single-faced Scale

## Mega Lock 13/16/19/25



A sturdy lock button locks the tape in any position and retracts the tape smoothly into the case.



	Cat.No.	Length	Width	QTY/ Inner carton	QTY/ Outer carton	N.W. (kgs)	G.W. (kgs)	M3	"Carton size (cm) D x W x H"	Stock available in Rotterdam
EU	S13-20EU	2m	13mm	120		13	15	0.056	37 x 56 x 27	×
	S13-30EU	3m				16	18			×
	S16-50EU	5m	16mm			28	30	×		
	S19-50EU		19mm			17	19	×		
S25-50EU	25mm	26	28	0.047	23 x 65 x 32	×				
ME	S13-20YMEB	2m x 6ft.	13mm	120		13	15	0.056	37 x 56 x 27	×
	S13-30YMEB	3m x 10ft.				16	18			×
	S16-35YMEB	3.5m x 12ft.	22			24	×			
	S16-50YMEB	5m x 16ft.	28			30	×			
	S19-55YMEB	5.5m x 18ft.	19mm			17	19	×		
	S19-75YMEB	7.5m x 25ft.				18	20	×		
	S25-55YMEB	5.5m x 18ft.	25mm			26	28	0.047	23 x 65 x 32	×
	S25-75YMEB	7.5m x 25ft.				28	30	×		



## Jumbo 19



Heavy duty traditional model for professionals. The **on-off, switching lock** button locks the tape in any position at any point.



	Cat.No.	Length	Width	QTY/ Inner carton	QTY/ Outer carton	N.W. (kgs)	G.W. (kgs)	M3	"Carton size (cm) D x W x H"	Stock available in Rotterdam
EU	JM19-35WEU	3.5m	19mm	6	60	13	15	0.047	23 x 65 x 32	○
	JM19-55WEU	5.5m				15	17			○
ME	JM19-55YMEB	5.5m x 18ft.				15	17			×



## Giant 25



Heavy duty traditional model for professionals. The **on-off, switching lock** button locks the tape in any position at any point.



	Cat.No.	Length	Width	QTY/ Inner carton	QTY/ Outer carton	N.W. (kgs)	G.W. (kgs)	M3	"Carton size (cm) D x W x H"	Stock available in Rotterdam
EU	GT25-55WEU	5.5m	25mm	4	32	20	22	0.047	23 x 65 x 32	○
	GT25-75WEU	7.5m				26	28			○
ME	GT25-55YMEB	5.5m x 18ft.				20	22			×
	GT25-75YMEB	7.5m x 25ft.	25	27	×					



# Pocket Tapes Single-faced Scale

## New NeoLock 13/16



**KDS** Compact size pocket tape with stopping device. Suitable for the stationary and DIY friends.



	Cat.No.	Length	Width	QTY/ Inner carton	QTY/ Outer carton	N.W. (kgs)	G.W. (kgs)	M3	"Carton size (cm) D x W x H"	Stock available in Rotterdam
EU	S13-20NEU	2m	13mm	6	120	10	12	0.064	40 x 57 x 28	×
	S16-30NEU	3m	16mm			18	20			○
	S16-50NEU	5m	16mm			24	26			×
ME	S13-20NYMEB	2m x 6ft.	13mm	6	120	10	12	0.064	40 x 57 x 28	×
	S16-35NYMEB	3.5m x 12ft.	16mm			18	20			×
	S16-50NYMEB	5m x 16ft.	16mm			24	26			×

## NeoLock 13/16



**KDS** The on-off, switching lock button locks the tape in position at any point and also controls retraction into the case.

	Cat.No.	Length	Width	QTY/ Inner carton	QTY/ Outer carton	N.W. (kgs)	G.W. (kgs)	M3	"Carton size (cm) D x W x H"	Stock available in Rotterdam
EU	KS13-20EU	2m	13mm	6	120	12	14	0.064	40 x 57 x 28	○
	KS16-35WEU	3.5m	16mm		60	20	22			○
	KS16-55WEU	5.5m	16mm		29	31	○			
ME	KS13-20YMEB	2m x 6ft.	13mm	6	120	13	15	0.064	40 x 57 x 28	×
	KS16-35YMEB	3.5m x 12ft.	16mm		22	24	×			
	KS16-50YMEB	5m x 16ft.	16mm		29	31	×			

## NeoLock 19/25



**KDS** A sturdy lock button locks the tape in any position and retracts the tape smoothly into the case. Rugged diamond-pattern (4-rivet) hook tip.



	Cat.No.	Length	Width	QTY/ Inner carton	QTY/ Outer carton	N.W. (kgs)	G.W. (kgs)	M3	"Carton size (cm) D x W x H"	Stock available in Rotterdam
<b>NeoLock 19</b>										
EU	KS19-50EU	5m	19mm	6	60	15	17	0.032	20 x 62 x 26	×
	KS19-70EU	7m				18	20			×
ME	★ KS19-55YMEB	5.5m x 18ft.	19mm	6	60	15	17	0.032	20 x 62 x 26	×
	KS19-75YMEB	7.5m x 25ft.				18	20			×
<b>NeoLock 25</b>										
EU	KS25-55WEU	5.5m	25mm	6	60	18	20	0.035	20 x 61 x 29	○
	KS25-75WEU	7.5m				27	29	0.064	40 x 57 x 28	○
	KS25-10EU	10m				31	33	×		
ME	★ KS25-55YMEB	5.5m x 18ft.	25mm	6	60	18	20	0.035	20 x 61 x 29	×
	★ KS25-75YMEB	7.5m x 25ft.				25	27	×		
	KS25-10YMEB	10m x 33ft.				28	30	0.064	40 x 57 x 28	×

# Pocket Tapes With push-pull type

## Free 13/16



Compact size pocket tape with smooth contoured line, the case fits comfortably in the hand. Most popular in the stationary and DIY fields. **Without belt-clip.**

	Cat.No.	Length	Width	QTY/ Inner carton	QTY/ Outer carton	N.W. (kgs)	G.W. (kgs)	M3	Carton size (Cm) D x W x H	Stock available in Rotterdam
EU	KF13-20EU	2m	13mm	6	120	8	10	0.064	40 x 57 x 28	○
	KF16-30EU	3m	16mm			17	19			
	KF16-50EU	5m	16mm			23	25			



## Compact Free 19



Compact size pocket tape with convenient stop button and belt-clip. Rugged diamond-pattern (4-rivet) hook tip

	Cat.No.	Length	Width	QTY/ Inner carton	QTY/ Outer carton	N.W. (kgs)	G.W. (kgs)	M3	Carton size (Cm) D x W x H	Stock available in Rotterdam
EU	CF19-50EU	5m	19mm	6	60	15	17	0.035	20 x 61 x 29	×
	CF19-70EU	7m				18	20			



## Compact Free 22



Compact size pocket tape with convenient stop button and belt-clip. Rugged diamond-pattern (4-rivet) hook tip

	Cat.No.	Length	Width	QTY/ Inner carton	QTY/ Outer carton	N.W. (kgs)	G.W. (kgs)	M3	Carton size (Cm) D x W x H	Stock available in Rotterdam
EU	CF22-50EU	5m	22mm	6	60	16	18	0.035	20 x 61 x 29	×



## Compact Free 25



Push-Pull type heavy duty pocket tape with convenient stop button and belt-clip. 25mm (1inch) wide tape with superior horizontal stand out.

	Cat.No.	Length	Width	QTY/ Inner carton	QTY/ Outer carton	N.W. (kgs)	G.W. (kgs)	M3	Carton size (Cm) D x W x H	Stock available in Rotterdam
EU	CF25-50EU	5m	25mm	6	60	18	20	0.035	20 x 61 x 29	×





## Pocket Tapes

### PRONEXT 19



New 19mm width 5.5m tape joined to well-reputed "PRONEXT" lineup!  
Eye-friendly 5.5m white tape cans measure 50cm longer than common 5m tapes!



	Cat.No.	Length	Width	QTY/ Inner carton	QTY/ Outer carton	N.W. (kgs)	G.W. (kgs)	M3	Carton size (Cm) D x W x H	Stock available in Rotterdam
EU	PX19-55WEUB DB	5.5m	19mm	12pcs. In POP carton box	24	6	7	0.017	30 x 49 x 12	×



### PRONEXT 25



New Generation Pocket Tapes for multi-users. Ergonomics Design case fits in your palm and End-HOOK Protector is in ideal position. 4-Colors variation (BLACK/ YELLOW/ RED/ BLUE) in one display Box. Colorful pocket tape will meet user's preference.

	Cat.No.	Length	Width	QTY/ Inner carton	QTY/ Outer carton	N.W. (kgs)	G.W. (kgs)	M3	Carton size (Cm) D x W x H	Stock available in Rotterdam
EU	PX25-50YEUB DB	5m	25mm	12pcs. In POP carton box	24	7	8	0.017	30 x 49 x 12	○
ME	PX25-55YME DB	5.5m x 18ft.	25mm	12pcs. In POP carton box	24	7	8	0.017	30 x 49 x 12	×



### Pocket Tape Holder



KDS Slot-in tape holder is an essential tool to support your outfield work.  
It fits KDS pocket tapes (Width: 19, 22, 25 and 27mm) only.



Cat.No.	QTY/ Inner carton	QTY/ Outer carton	N.W. (kgs)	G.W. (kgs)	M3	Carton size (Cm) D x W x H	Stock available in Rotterdam
SH-02	10	60	4	5	0.032	39 x 47 x 17	×

### Mini-Rod

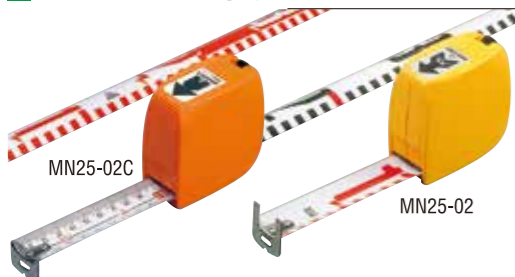

Mini-Rod is extremely useful for taking short distance photo-records, and survey work, having two kinds of special 5mm graduations on both side of the tape.

Cat.No.	Length	Width	QTY/ Inner carton	QTY/ Outer carton	N.W. (kgs)	G.W. (kgs)	M3	Carton size (Cm) D x W x H	Stock available in Rotterdam
★ MN25-02	2m Rod	25mm	10	50	6	8	0.017	21 x 41 x 19	×
MN25-02C	2m + 2m Rod								
★ MN25-02E	6 1/2 feet								
★ MN25-02ET	6 1/2ft (10ft)								

## Pocket Tapes

### Steel Diameter tape



Diameter rules provide accuracy in an ordinary linear measurement plus diameter measurement.

F10-02DM

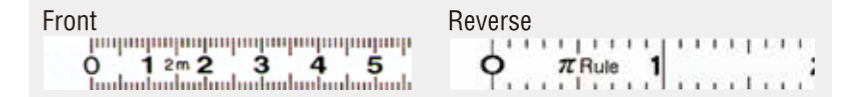

Cat.No.	Length	Width	QTY/ Inner carton	QTY/ Outer carton	N.W. (kgs)	G.W. (kgs)	M3	Carton size (Cm) D x W x H	Stock available in Rotterdam
★ F10-02DM	2m	10mm	12	240	14	16	0.017	21 x 41 x 19	×
★ F10-02EP	64ths								
F10-02EPD	100ths								

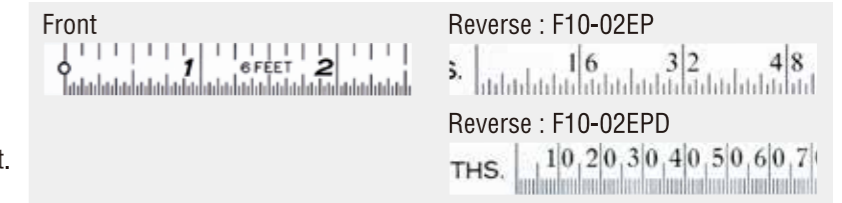

### Steel Flat tape

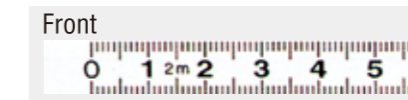

KDS Flat rules are most useful in machinery or dress-measuring applications.

Cat.No.	Length	Width	QTY/ Inner carton	QTY/ Outer carton	N.W. (kgs)	G.W. (kgs)	M3	Carton size (Cm) D x W x H	Stock available in Rotterdam
F10-02	2m	10mm	12	240	14	16	0.017	21 x 41 x 19	×

### Rain Drop



A specially designed slim & lightweight pocket tape. Rain Drop is available in 2 colors, Yellow and Red and each is fitted with a keychain for ease in carrying.

Cat.No.	Length	Width	QTY/ Inner carton	QTY/ Outer carton	N.W. (kgs)	G.W. (kgs)	M3	Carton size (Cm) D x W x H	Stock available in Rotterdam
RA06-10YE	1m	6mm	12	60	2	3	0.012	17 x 43 x 17	×
RA06-10RE									
RA06-20YE	2m	6mm	12	60	3	4	0.012	17 x 43 x 17	×
RA06-20RE									

### Setting Measure

Reverse graduation also available

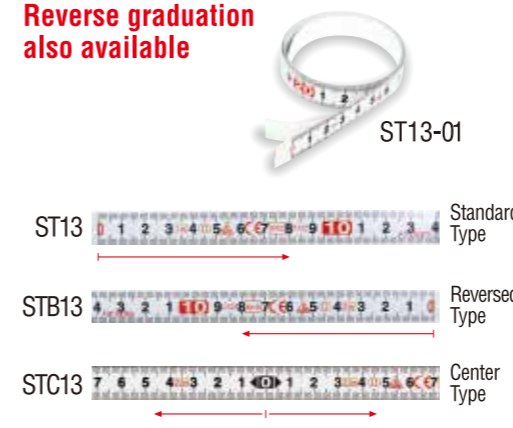

Stick-on Tape Measure with self-adhesive.

Use as customized measure for workbenches, saw tables machinery, desks, countertops, poles, walls, columns, etc.

Cat.No.	Length	Width	QTY/ Inner carton	QTY/ Outer carton	N.W. (kgs)	G.W. (kgs)	M3	Carton size (Cm) D x W x H	Stock available in Rotterdam
ST13-01EU BP	1m CE mark	13mm	10	60	2.2	2.7	0.024	49 x 33 x 15	○
ST13-02EU BP	2m CE mark				3.2	3.7			○
ST13-05 BP	5m				10	11			○
STB13-01EU BP	1m CE mark	13mm	10	60	2.2	2.7	0.024	49 x 33 x 15	×
STB13-02EU BP	2m CE mark				3.2	3.7			○
STB13-05 BP	5m				10	11			×
STC13-05EU BP	2.5m+2.5m CE mark	13mm	10	60	10	11	0.024	49 x 33 x 15	×
ST13-05ME BP	5m x 16ft.				10	11			×



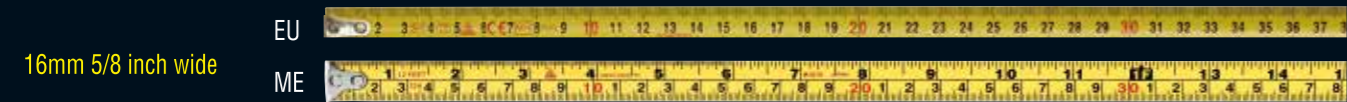

# Pocket Tapes Marking specifications and graduations



## Double faced Tape









# Pocket Tapes packaging-1



















Name	Graduation	Cat. No.	Length	Width	QTY/ Inner carton 	QTY/ Outer carton 					
	EU	GGEVO19-55EU	5.5m	19mm		4	 Packed 10 inner cartons	40			
		GGEVO25-55EU		25mm							
		GGEVO25-75EU	7.5m	25mm							
	GGEVO25-10EU	10m	25mm								
	ME	GGEVO19-55ME	5.5m x 18ft.	19mm							
		GGEVO25-55ME		25mm							
		GGEVO25-75ME	7.5m x 25ft.	25mm							
	GGEVO25-10ME	10m x 33ft.	25mm								
E(inch)	GGEVO25-75E	25ft.	25mm								
GGEVO25 Drop Protection 	EU	GGEVO25-55WME AR	5.5m x 18ft.	25mm		4	 Packed 10 inner cartons	40			
		GGEVO25-75WME AR	7.5m x 25ft.								
	E(inch)	GGEVO25-75WE AR	25ft.								
NEO DURA-G(Gum) 	EU	DVG19-30EU	3m	19mm		4	 Packed 10 inner cartons	40			
		DVG19-50EU	5m	25mm							
		DVG25-50EU		25mm							
	ME	DVG19-35ME	3.5m x 12ft.	19mm							
		DVG19-55ME	5.5m x 18ft.	19mm							
		DVG25-50ME	5.0m x 16ft.	25mm							
DVG25-75ME	7.5m x 25ft.										
E(inch)	DVG25-75E	25ft.	25mm								
NEO DURA-M(Metal) 	EU	DVZ19-30EU	3m	19mm		6	 Packed 10 inner cartons	60			
		DVZ19-50EU	5m	25mm							
		DVZ25-50EU									
		DVZ25-80EU	8m	25mm						4	
PRO DURA 16/19/25 	EU	PDX16-30EU	3m	16mm		6	 Packed 10 inner cartons	60			
		PDX16-50EU	5m	19mm							
		PDX19-50EU	5m	25mm							
		PDX25-50EU									
	ME	PDX25-75EU	7.5m	25mm							
		PDX16-35ME	3.5m x 12ft.	16mm							
		PDX16-55ME	5.5m x 18ft.	19mm							
		PDX19-55ME	5.0m x 16ft.	25mm							
PDX25-50ME	5.0m x 16ft.										
PDX25-75ME	7.5m x 25ft.										
E(inch)	PDX25-75E	25ft.	25mm								
Both side Print 19/22/25 	EU	ZS19-50EU	5m	19mm		6	 Packed 10 inner cartons	60			
		ZS19-70EU	7m	22mm							
		ZS22-50EU	5m	25mm							
		ZS25-50EU									
		ZS25-80EU	8m	25mm					4		40
		ZS25-10EU	10m	25mm							



## Pocket Tapes packaging-2

Name	Graduation	Cat. No.	Length	Width	QTY/ Inner carton 	QTY/ Outer carton 			
Mega Lock 13/16/19/25 	EU	S13-20EU	2m	13mm		Packed 20 inner cartons	120		
		S13-30EU	3m						
		S16-50EU	5m	16mm				Packed 10 inner cartons	60
		S19-50EU		19mm					
		S25-50EU		25mm					
	ME	S13-20YMEB	2m x 6ft.	13mm		Packed 20 inner cartons	120		
		S13-30YMEB	3m x 10ft.						
		S16-35YMEB	3.5m x 12ft.	16mm					
		S16-50YMEB	5.0m x 16ft.						
		S19-55YMEB	5.5m x 18ft.	19mm					
S19-75YMEB		7.5m x 25ft.							
S25-55YMEB		5.5m x 18ft.	25mm						
S25-75YMEB	7.5m x 25ft.								
Jumbo 19 Giant 25 	EU	JM19-55WEU	5.5m	19mm	Packed 10 inner cartons	6			
		GT25-55WEU		25mm					
		GT25-75WEU	7.5m						
	ME	JM19-55YMEB	5.5m x 18ft.	19mm	Packed 10 inner cartons	60			
GT25-55YMEB	25mm								
GT25-75YMEB		7.5m x 25ft.							
New NeoLock 13/16 	EU	S13-20NEU	2m	13mm		Packed 20 inner cartons	120		
		S16-30NEU	3m						
		S16-50NEU	5m						
	ME	S13-20NYMEB	2m x 6ft.	13mm					
		S16-35NYMEB	3.5m x 12ft.						
S16-50NYMEB	5.0m x 16ft.	16mm							
NeoLock 13/16 	EU	KS13-20EU	2m	13mm		Packed 10 inner cartons	60		
		KS16-35WEU	3.5m						
		KS16-55WEU	5.5m						
	ME	KS13-20YMEB	2m x 6ft.	13mm					
		KS16-35YMEB	3.5m x 12ft.			16mm			
		KS16-50YMEB	5.0m x 16ft.						
NeoLock 19/25 	EU	KS19-50EU	5m	19mm		Packed 10 inner cartons	60		
		KS19-70EU	7m						
		KS25-55WEU	5.5m	25mm					
		KS25-75WEU	7.5m						
		KS25-10EU	10m						
	ME	KS19-55YMEB	5.5m x 18ft.	19mm					
		KS19-75YMEB	7.5m x 25ft.						
		KS25-55YMEB	5.5m x 18ft.	25mm					
		KS25-75YMEB	7.5m x 25ft.						
		KS25-10YMEB	10m x 33ft.						

## Pocket Tapes packaging-3

Name	Graduation	Cat. No.	Length	Width	QTY/ Inner carton 	QTY/ Outer carton 		
Free 13/16 	EU	KF13-20EU	2m	13mm		6	Packed 20 inner cartons	120
		KF16-30EU	3m	16mm				
		KF16-50EU	5m					
Compact Free 19/22/25 	EU	CF19-50EU	5m	19mm		6	Packed 10 inner cartons	60
		CF19-70EU	7m					
		CF22-50EU	5m	22mm				
		CF25-50EU		25mm				
PRONEXT 19/25 	EU	PX19-55WEUB DB	5.5m	19mm		12	Packed 2 inner POP cartons	24
	ME	PX25-50YEUB DB	5m					
	ME	PX25-55YME DB	5.5m x 18ft.	25mm				
Pocket tape holder 		SH-02				10	Packed 6 inner cartons	60
Mini-Rod 		MN25-02	2m Rod	25mm		10	Packed 5 inner cartons	50
		MN25-02C	2m+2m Rod					
		MN25-02E	6 1/2feet					
		MN25-02ET	6 1/2ft(10th)					
Steel Diameter tape 		F10-02DM	2m	10mm		12	Packed 10 inner cartons	120
		F10-02EP	64ths					
		F10-02EPD	100ths					
		F10-02	2m					
Rain Drop 		RA06-10YE	1m	6mm		12	Packed 5 inner cartons	60
		RA06-10RE						
		RA06-20YE	2m					
		RA06-20RE						
Setting Measure 		ST13-01EUBP	1m CEmark	13mm		10	Packed 6 inner cartons	60
		ST13-02EUBP	2m CEmark					
		ST13-05BP	5m					
		STB13-01UEBP	1m CEmark					
		STB13-02EUBP	2m CEmark					
		STB13-05BP	5m					
		STC13-05EUBP	2m+2m CEmark					
		STB13-05ME BP	5m x 18ft.					
Escargots		RSB-2BP	2m	16mm		6	Packed 10 inner cartons	60

# Long Tapes

## SPEED TECRON®

**4x Super rewind** 1wind-up,4rewinding

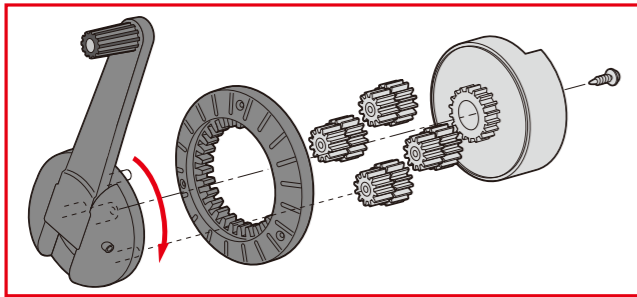

Drop-shock resistant elastomer tip



Slip resistant elastomer grip

## Speed Tecron-10 "4x Super rewind" Nylon coating stainless steel long tapes

### Stainless Steel

**Quad-Speed** rewind, **extruded nylon coated stainless steel** long tape. Easy to read black and red marking with quick reading meter figures. Standard tension:20°C 50N [Tape thickness: 0.4mm]

Cat.No.	Length	Width	QTY/ Inner carton	QTY/ Outer carton	N.W. (kgs)	G.W. (kgs)	M3	Carton size (Cm) D x W x H
SST10-30	30m	10mm	1	5	5	7	0.022	30 x 31 x 23
SST10-50	50m				6	8	0.027	30 x 35 x 26

※ White tape and metric graduation only



## Speed Tecron-13 "4x Super rewind" Nylon coating steel long tapes

With the **Quad-Speed** Tecron, turn the handle once and the tape **rewinds four times!**

And the **nylon coating** on the tape blades means **it's waterproof. 10mm wide tape is also available.** Standard tension:20°C 100N [Tape thickness: 0.45mm]

Cat.No.	Length	Width	QTY/ Inner carton	QTY/ Outer carton	N.W. (kgs)	G.W. (kgs)	M3	Carton size (Cm) D x W x H
ST13-30	30m	13mm	1	5	7	9	0.022	30 x 31 x 23
ST13-50	50m				10	12	0.027	30 x 35 x 26
ST13-30ME	30m x 100ft				7	9	0.022	30 x 31 x 23
ST13-50ME	50m x 164ft				10	12	0.027	30 x 35 x 26
* ST13-30ME DH	30m x 100ft				7	9	0.022	30 x 31 x 23
* ST13-60ME DH	60m x 200ft				10	12	0.027	30 x 35 x 26

[\* DH: with a Hook]



# Long Tapes

## Tecron-13

Nylon coating steel long tapes

Multi-purpose, easy to use, **Nylon coating long steel** measuring tapes. Standard tension:20°C 100N [Tape thickness: 0.45mm]

Cat.No.	Length	Width	QTY/ Inner carton	QTY/ Outer carton	N.W. (kgs)	G.W. (kgs)	M3	Carton size (Cm) D x W x H
TL13-30	30m	13mm	1	5	6	8	0.022	30 x 31 x 23
TL13-50	50m				8	10	0.027	30 x 35 x 26
TL13-30ME	30m x 100ft				6	8	0.022	30 x 31 x 23
TL13-50ME	50m x 164ft				8	10	0.027	30 x 35 x 26



## Unilong-13

Steel long tapes

Unilong tapes are made from **hardened and tempered high-carbon steel** which has been treated with phosphate to protect against rust and corrosion. Standard tension:20°C 100N [Tape thickness: 0.23mm]

Cat.No.	Length	Width	QTY/ Inner carton	QTY/ Outer carton	N.W. (kgs)	G.W. (kgs)	M3	Carton size (Cm) D x W x H
UL13-30	30m	13mm	1	5	6	8	0.022	30 x 31 x 23
UL13-50	50m				8	10	0.027	30 x 35 x 26
UL13-30ME	30m x 100ft				6	8	0.022	30 x 31 x 23
UL13-50ME	50m x 164ft				8	10	0.027	30 x 35 x 26



## Kaclong-10

Steel long tapes

Economical type of long tape, in an ABS plastic case, and equipped with vinyl wrist strap.

Standard tension:20°C 20N [Tape thickness: 0.18mm]

Cat.No.	Length	Width	QTY/ Inner carton	QTY/ Outer carton	N.W. (kgs)	G.W. (kgs)	M3	Carton size (Cm) D x W x H
* KL10-10	10m	10mm	6	24	5	7	0.016	24 x 56 x 12
KL10-20	20m				7	9	0.022	29 x 63 x 12
* KL10-30	30m				12	14	0.022	29 x 63 x 12
KL10-10ME	10m x 33ft				5	7	0.016	24 x 56 x 12
KL10-20ME	20m x 66ft				7	9	0.022	29 x 63 x 12
KL10-30ME	30m x 100ft				12	14	0.022	29 x 63 x 12





# Long Tapes

## Speed Tufmic-12R

"4x Super rewind" Glass fiber long tapes



With the Quad-Speed Tufmic, turn the handle once and the tape rewinds four times!

Tufmic glass-fiber tapes will not stretch, shrink or cases, and are resistant to water, humidity, temperature and most chemicals. Highly recommended for civil-engineers, land surveyors, and those who insist on quality instruments. [Tape thickness: 0.48mm]

Cat.No.	Length	Width	QTY/ Inner carton	QTY/ Outer carton	N.W. (kgs)	G.W. (kgs)	M3	Carton size (Cm) D x W x H
QUAD-SPEED REWIND				Standard tension 20°C 10N				
SGR12-30	30m	12mm	1	5	5	7	0.027	31 x 33 x 26
SGR12-50	50m				6	8	0.035	31 x 37 x 31
SGR12-1H	100m				9	11	0.052	31 x 45 x 37
SGR12-120	120m				12	14		

## Tufmic-12C/12R

Glass fiber long tapes



Tufmic glass-fiber tapes will not stretch, shrink or cases, and are resistant to water, humidity, temperature and most chemicals. Highly recommended for civil-engineers, land surveyors, and those who insist on quality instruments. [Tape thickness: 0.48mm]

Cat.No.	Length	Width	QTY/ Inner carton	QTY/ Outer carton	N.W. (kgs)	G.W. (kgs)	M3	Carton size (Cm) D x W x H	
CAPSULE TYPE				Standard tension 20°C 10N					
GK12-10	10m	12mm	1	10	3	5	0.008	14 x 37 x 15	
GK12-20	20m				4	6	0.015	18 x 41 x 20	
GK12-30	30m				5	7	0.020	21 x 43 x 22	
OPEN TYPE				Standard tension 20°C 10N					
GR12-30	30m	12mm	1	10	3	5	0.029	31 x 41 x 23	
GR12-50	50m				5	7	0.036	34 x 41 x 26	
GR12-1H	100m				5	8	10	0.028	32 x 38 x 23

## Walking Measure

\*Walking-Measure is the industry's best choice for quick and easy measuring over a variety of surfaces and it accurately measures while you are walking. One person can measure faster than with a tape measure and you are not limited to length of the tapes.

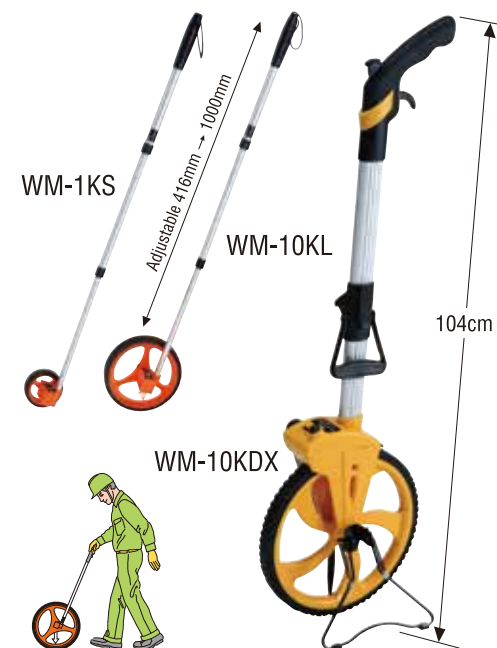

Cat.No.	Min. measuring unit	Max. measuring distance	Wheel dia.	QTY/ Inner carton	QTY/ Outer carton	N.W. (kgs)	G.W. (kgs)	M3	Carton size (Cm) D x W x H
WM-1KS	1cm	1km	10cm	6	12	6	8	0.084	62 x 40 x 34
WM-10KL	10cm	10km	20cm			10	12	0.123	58 x 40 x 53
WM-10KDX			32cm	1	4	8	14	0.154	36 x 67 x 64



### Low-friction, extruded nylon coated Stainless steel tape

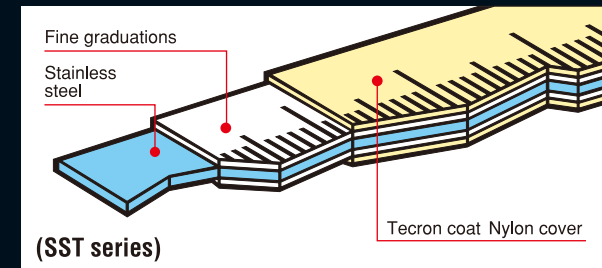

### Low-friction, steel tape

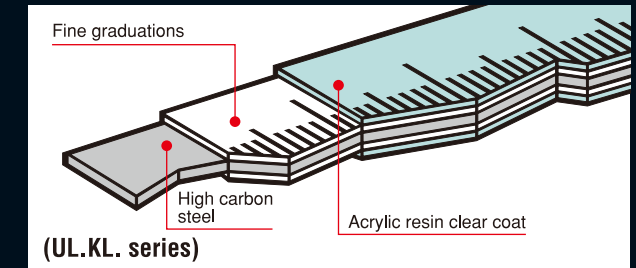

### Low-friction, extruded nylon coated steel tape

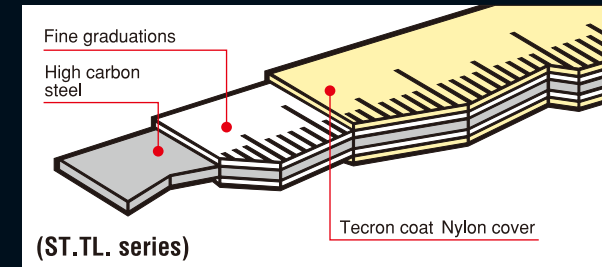

### Glass-fiber tape

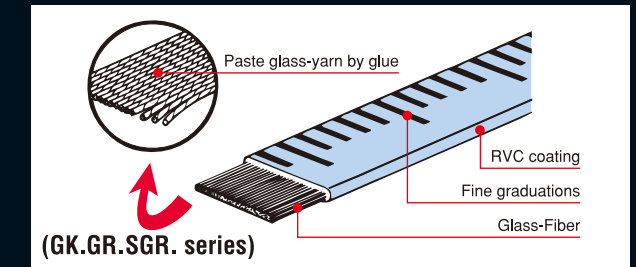

# Long Tapes Marking specifications and graduations

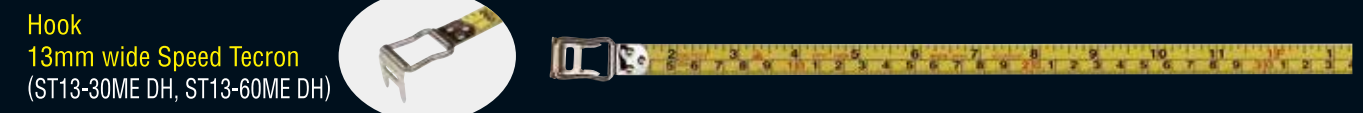
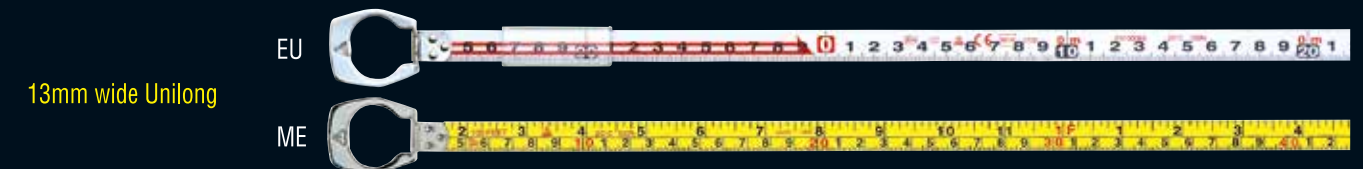

### ZERO point manner

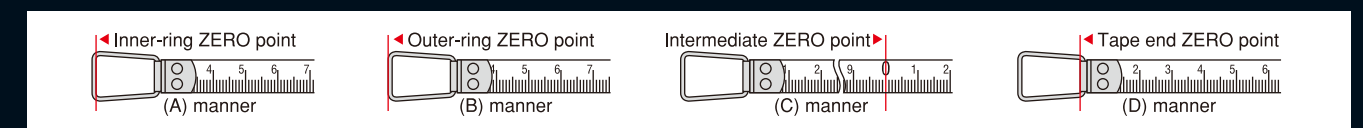

## Long Tapes packaging

Name	Cat. No.	Length	Width	QTY/Inner carton 	QTY/Outer carton 	
Speed Tecron-10	SST10-30	30m	10mm			
	SST10-50	50m				
Speed Tecron-13 	ST13-30	30m	13mm		1	
	ST13-50	50m				
	ST13-30ME	20m x 100ft.				
	ST13-50ME	50m x 164ft.				
	ST13-30ME DH	30m x 100ft.				
	ST13-60ME DH	60m x 200ft.				
Tecron-13 	TL13-30	30m	13mm		1	
	TL13-50	50m				
	TL13-30ME	30m x 100ft.				
	TL13-50ME	50m x 164ft.				
Unilong-13 	UL13-30	30m	13mm		1	
	UL13-50	50m				
	UL13-30ME	30m x 100ft.				
	UL13-50ME	50m x 164ft.				
Kaclong-10 	KL10-10	10m	10mm		6	
	KL10-20	20m				
	KL10-30	30m				
	KL10-10ME	10m x 33ft.				
	KL10-20ME	20m x 66ft.				
	KL10-30ME	30m x 100ft.				
Speed Tufmic-12R 	SGR12-30	30m	12mm		5	
	SGR12-50	50m				
	SGR12-1H	100m				
	SGR12-120	120m				
Tufmic-12C 	GK12-10	10m	12mm		1	
	GK12-20	20m				
	GK12-30	30m				
Tufmic-12R 	GR12-30	30m	12mm		1	
	GR12-50	50m				
	GR12-1H	100m				
					Packed 5 inner cartons	5
					Packed 4 inner cartons	24
					Packed 5 inner cartons	5
					Packed 10 inner cartons	10
					Packed 5 inner cartons	5

## Electronic Products

### Tracking Gauge



KDS Tracking Gauge TG-39 is a novel product, equipped with a transparent type optical sensor and a customized micro-computer, providing a digitally displayed tracking gauge that is especially effective in measuring the dimensions of a vehicle body and frame when being realigned.

Detection	Transparent Type Photo-Interrupter
Accuracy	±3 mm Including a Quantization Error
Min. unit:	0.001m (1 mm)
Measurement Range	In: 0.315 - 3.200 m Out: 1.050 - 3.900 m
Function	Stopping device for each pole, Stop lever in last pole, Zero-set, Hold, <b>10 Memory reference</b> , Memory input, Display backlight, Selection of measuring unit, Inverse, Selection of automatic power-off, Memory clear
Power	4 pieces of R6 or LR6 Battery
Battery Life	<b>About 45 hours</b> in normal continuous use (Manganese Batteries are used)
Operable Temperature	0 to 40°C Celsius
Weight ( Main Unit and Batteries )	1.7 kg
Dimensions	1,000 (L) × 44 (W) × 73 (H)
Accessories( Included )	Carrying Case, Four R6 Batteries, Two Holders, Three Types of Tip Attachment

The Digital Tracking Gauge, designed for use in automotive body work.

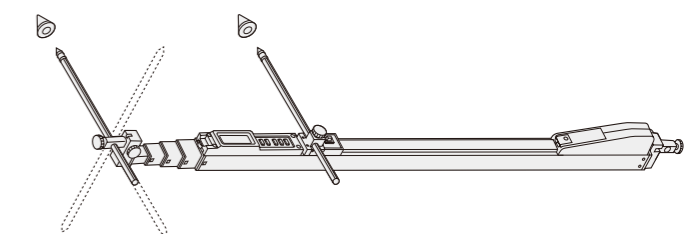
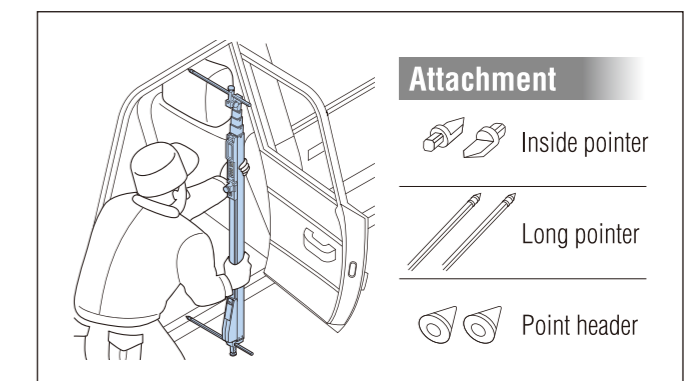

Cat.No.	Inner (pcs.)	Outer (pcs.)	N.W. (kgs)	G.W. (kgs)	M3	Carton size (Cm) D x W x H
TG-39	1	2	4	6	0.021	12 x 104 x 17



## Electronic Products

### Digital Pole Measures



Digital Pole Measures are an excellent way to measure diagonal and inside length.

Six sectional measuring rod with 10 memories.

Cat.No.	Inner (pcs.)	Outer (pcs.)	N.W. (kgs)	G.W. (kgs)	M3	Carton size (Cm) D x W x H
DM-20	1	4	5	7	0.024	25 x 60 x 16
DM-40			7	9	0.038	25 x 93 x 16
DM-50			9	11	0.045	25 x 110 x 16
DM-60			10	12	0.051	25 x 127 x 16

### Digital Pole Measures-S



Simple model of Digital Pole Measures without memory function.

Each of telescoping rods provide accurate measurement and display.

Cat.No.	Inner (pcs.)	Outer (pcs.)	N.W. (kgs)	G.W. (kgs)	M3	Carton size (Cm) D x W x H
DMN-40	1	4	7	9	0.038	25 x 93 x 16
DMN-50			9	11	0.045	25 x 110 x 16

Pole-type measure makes your work easy!

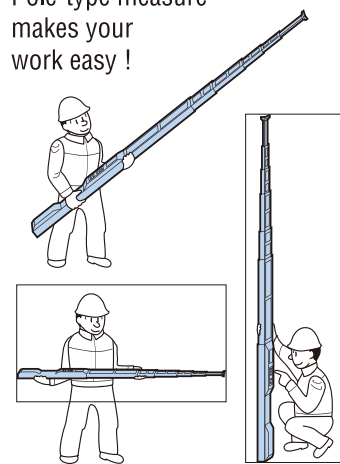

Cat. No.	DM-20	DM-40	DM-50	DM-60	DMN-40	DMN-50
Min. length	0.550m	0.880m	1.050m	1.220m	0.880m	1.050m
Max. length	2.000m	4.000m	5.000m	6.000m	4.000m	5.000m
Outside dimension	550 X 44 X 73mm	880 X 44 X 73mm	1050 X 44 X 73mm	1220 X 44 X 73mm	880 X 44 X 73mm	1050 X 44 X 73mm
Weight	1.2kg	1.7kg	1.95kg	2.2kg	1.7kg	1.95kg
Detection	Transmissive Photo Interrupter					
Accuracy	±2mm(including quantization error)					
Min. unit	0.001m (1 mm)					
Display	Digital 6 digit, LCD display					
Operable Temperature	0 to 40°C Celsius					
Power	4 pieces of R6 or LR6 Battery					
Battery life	<b>About 45 hours</b> in normal continuous use (Manganese Batteries are used)					
Accessories	Exclusive carrying case, 4 pieces of R6 battery, Instruction Manual					
<b>Function</b>						
Memory references	10 memory				no	
Stopping device of each pole					Yes	
Stop lever in last pole					Yes	
Zero-set					Yes	
Hold (Temporary hold of displayed value)					Yes	
Inverse	Yes				no	
Automatic power saving	5 min, 30 min and cancellation				5 min	
Selection of measuring unit	Metric, inch, Sixteenths(1/16) and 10THS/100THS of feet				Metric only	
Display backlight	Yes					

## Electronic Products

### Digital Wall detector



The Digital Wall Detectors join the KDS Layout Tools line!  
Detects metal objects in the wall by simply pushing a button.  
Recommended for professional craftsmen as well as DIY users.

- 1) Automatic calibration for easy and precise detection.
- 2) Graphic display indicates detected material.
- 3) IP54 protects from the rain and dirt when working outside.

Product specifications	Cat. No.	
Detectable materials /Max detection depth:	DS-120	DS-100
Ferrous metal	120mm	100mm
Non-ferrous metal	80mm	
Live wiring	50mm	
Wooden studs	38mm	No
Display backlight	Yes	No
Working temperature (Celsius)	-10°C~+50°C	-10°C~+45°C
Storage temperature (Celsius)	-20°C~+70°C	
Weight	270g	260g
Dimension	200 x 86 x 32mm	
Original case	Yes	No
Power supply	1piece x 9 V 6LR61	

Cat. No.	CTN (pcs.)	N.W. (kgs)	G.W. (kgs)	M3
DS-120	10	5	6	0.043
DS-100		6	7	

### Durometer ~Hardness Gauge~

A "Durometer" is used for measuring the hardness of rubber products such as tires at a high accuracy.

The KDS durometer conforms to JIS and international standards and makes it possible to make measurement easily in a short time.

- 1) Functionally designed for compact and easy operation.
- 2) Dial face is graduated in equal, one degree increments for easy reading.
- 3) Magnesium alloy casing ensures long durability.



Product specifications	Cat. No.			
Type	DM-104A	DM-204A	DM-107E	DM-207E
Hardness indication	Standard type	Two-hands type	Standard type	Two-hands type
Accuracy	One degree for one gradation			
Weight	200g		225g	
Applicable Std.	JIS K 6253 ISO 7619 ASTM D 2240		JIS K 6253	
Meas Object	Ordinary rubber		Soft rubber	
Weight application	550-8050mN (56.1-821.1gf)			
Pointer				

Cat. No.	CTN (pcs.)	N.W. (kgs)	G.W. (kgs)	M3
DM-104A	40	11	13	0.031
DM-204A				
DM-107E		12	14	
DM-207E				



# Marking Tools / Straight Rules

## Anchor Line

KDS® Anchor Lines are equipped with a strong magnet and replaceable needle for both steel and wooden construction.

Cat.No.	Length	Width	QTY/ Inner carton	QTY/ Outer carton	N.W. (kgs)	G.W. (kgs)	M3
★SF-16B	4.5m	400g fixed	6	24	13	15	0.031

### Accessories

Cat.No.	Discription	Dize	Weight	QTY/ Inner carton	N.W. (kgs)	G.W. (kgs)	M3
AW-16-400	Plumb bob	123 x ø30	400g	12	5	7	0.008



## Straight Rules

Made from hardened and tempered steel. "SH-series" are supplied with an easy to read anti-glare chrome plated finish, which provides marked contrast to the permanent figures and graduations. Stainless steel "SS-series" are also available for popular use.

Cat.No.	Length	Width	QTY/ Inner carton	QTY/ Outer carton	N.W. (kgs)	G.W. (kgs)	M3
<b>Hard Chrome Plated</b>							
SH-15	150mm	15mm	100	300	2.9	3.9	0.003
SH-30	300mm	25mm	50	150	10.3	11.3	0.006
SH-60	600mm	30mm	—	50	9.4	10.4	0.010
SH-100	1000mm	35mm	—	25	22.5	23.5	0.009
<b>Stainless Steel</b>							
SS1ME	150mm x 6"	15mm	—	300	11	13	0.020
SS3ME	300mm x 12"	25mm	—	200	14	15	0.010
SS6ME	600mm x 24"	30mm	—	80	15	16	0.010
SS10ME	1000mm x 36"	35mm	—	—	13	14	0.007
SS15ME	1500mm x 60"	40mm	—	30	30	32	0.029
SS20ME	2000mm x 78"		—		38	40	0.034



Hard Chrome Plated

Stainless Steel

# Wooden Chisels / Planers



## Wooden Chisels



KDS® chisel blade and tang are made from carbon steel and are tempered and beveled, with a tough, impact - resistant plastic handle. Available in standard tang, and in eight special types for crafts, wood carving, and other elaborate work.

Long Type						
Cat.No.	Width	CTN(Unit.)	N.W.(kgs)	G.W.(kgs)	M3	
EN-01BP	6mm	60	14	16	0.033	
EN-015BP	9mm	60	15	17	0.033	
EN-02BP	12mm	60	16	18	0.033	
EN-025BP	15mm	60	11	12	0.044	
EN-03BP	19mm	60	11	12	0.044	
EN-035BP	22mm	60	12	14	0.044	
EN-04BP	25mm	60	13	15	0.044	
EN-05BP	32mm	60	15	17	0.044	
EN-06BP	38mm	60	17	19	0.044	
EN-3SV	12, 19, 25mm	48 set	26	28	0.042	
EN-4SV	6, 12, 19, 25mm	32 set	22	24	0.038	
EN-6SV	6, 12, 15, 19, 25, 32mm	24 set	27	29	0.049	
Special type						
Cat.No.	Type	Width	CTN(Unit.)	N.W.(kgs)	G.W.(kgs)	M3
No.3101	flat	9mm	100	10	12	0.041
No.3103	flat	15mm	100	10	12	0.041
No.3104	shallow gouge	9mm	100	10	12	0.041
No.3105	gouge	9mm	100	10	12	0.041
No.3106	gouge	12mm	100	10	12	0.041
No.3107	v-parting	9mm	100	10	12	0.041
No.3108	bent gouge	9mm	100	10	12	0.041
No.3109	skew	9mm	100	10	12	0.041
No.3166	6pce. Set No.3101, No.3103, No.3105, No.3106, No.3107, No.3109		24 set	15	17	0.050
No.3168	8pce. Set No.3101, No.3103, No.3104, No.3105, No.3106, No.3107, No.3108, No.3109		24 set	21	23	0.067

## Planers



DS® brand planes are made from high grade carbon eel with a Japanese white oak body. No.5710 for hamfer molding, No.5720 for round molding, and o.5730 for mini smooth are replaceable and can be sharpened for longer use. Available in a range of sizes r elaborate work. Available only in Japanese version.

Cat.No.	Blade	CTN(Unit.)	N.W.(kgs)	G.W.(kgs)	M3
No.5710	30mm	60	18	20	0.047
No.5720	30mm	60	14	16	0.033
No.5730	30mm	60	14	16	0.033
No.5742	42mm	30	11	13	0.023
No.5748	48mm	30	15	17	0.024
No.5750	50mm	20	15	17	0.024
No.5758	58mm	20	19	21	0.003
No.5760	60mm	20	19	21	0.003