

Omschrijving:

Led armatuur Sola 18W 4000K IP65 IK10 nood



LED armatuur SOLA met ingebouwde noodunit van 3h. Slagvaste polycarbonaat behuizing IP65 IK10. Voorzien van 'toolless' aansluitklemmen voor een snelle en makkelijke montage. Met kabelingangen langs boven en zijkant. Met ingebouwde noodunit 3 uur 3W 250/300lm.

Technische eigenschappen

Referentie	SO184EME
EAN code	5420076217679
ETIM code	EC002892

Elektrische eigenschappen

Systeem vermogen (W)	18
LED vermogen (W)	17
Aansluitspanning (Vac)	200-240
Frequentie (Hz)	50
Driver inbegrepen	ja
Driver intern/extern	intern
Dimbaar	nee
Flicker free	ja
Power factor	0,95
Aansluitkabel	no
Driver output (V)	27-42
Driver output (mA)	500
Isolatieklasse	II
Energie klasse	A+
Aantal op 16A C curve	38
Aantal op 16A D curve	60
Inrush current driver	

Garantie en certificatie

Levensduur (u)	54.000 L80B50
Garantie (jaar)	5
ENEC	nee

Lichttechnische eigenschappen

Lichtbundel(°)	120
Kleurtemperatuur (K)	4000
Kleurweergave CRI	82
UGR	<23
Kleurvastheid SDCM	3
Lumen output (Lm)	1650
Lm/W	91
Flux code	47 78 94 100 95
Ledchip	SMD2835
Ledfabrikant	Honglitronic
Aantal LEDs	99
Fotobiologische klasse	RG1

Afmeting en materiaal eigenschappen

Afmetingen (LxBxH)	290x290x103mm
Gewicht (kg)	1,675
Kleur	wit RAL9003
Werktemperatuur (°C)	-20~+50
IP waarde	IP65
IK waarde	IK10
UV bestendig	ja
Zeewater bestendig	nee
UL 94	
Aantal in bulk	4
Aantal op pallet	80
Minimum bestelaantal	1
Stockartikel	ja

Lumen distribution

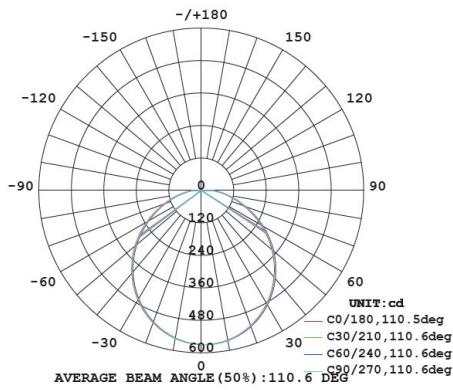

Distance curve:

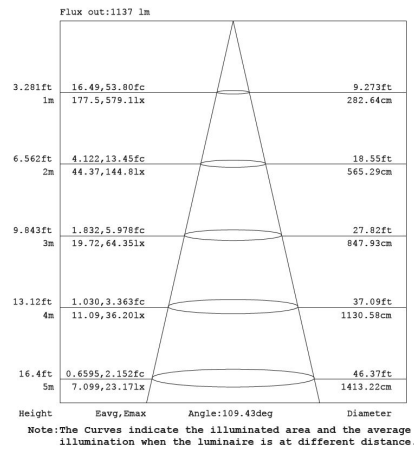

Spectrum distribution

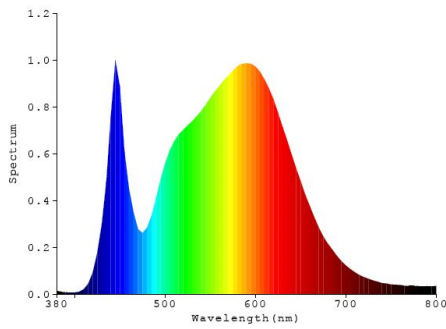

Lumendrop

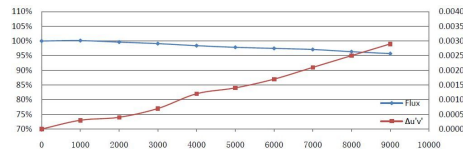

Afmetingen

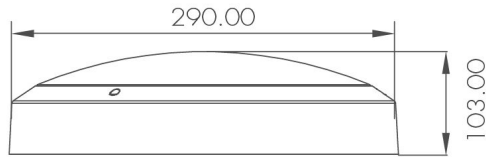

Mogelijkheden

Dimming:

Triac	<input type="checkbox"/>
1-10V	<input checked="" type="checkbox"/>
DALI	<input checked="" type="checkbox"/>
KNX	<input type="checkbox"/>
DMX	<input type="checkbox"/>
Drukknop	<input type="checkbox"/>
RF	<input type="checkbox"/>
Zigbee	<input type="checkbox"/>
Z Wave	<input type="checkbox"/>
Easywave	<input type="checkbox"/>
WiFi	<input type="checkbox"/>

Lichtsturing:

Sensor on/off	<input checked="" type="checkbox"/>
Sensor dim	<input checked="" type="checkbox"/>
Fotocel	<input checked="" type="checkbox"/>
Nood	<input checked="" type="checkbox"/>

Aansluitschema

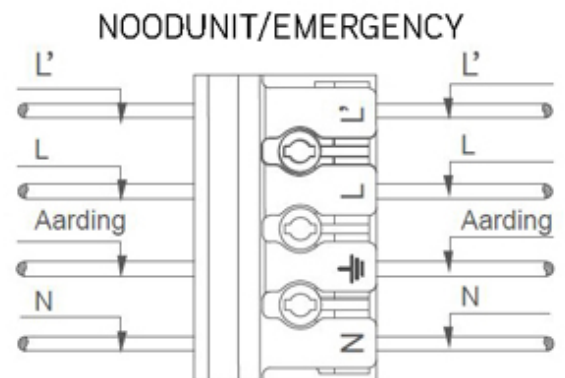
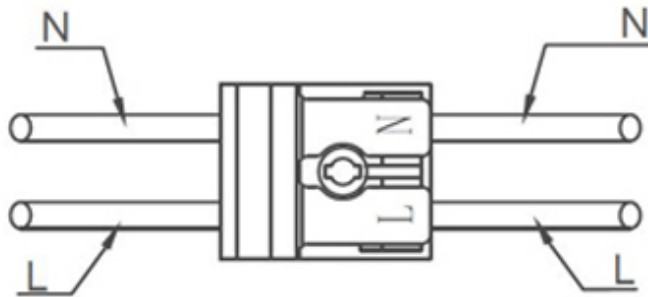

L' = 230V continu
L = 230V after switch