

















Ledklok PHB2 is de referentie voor het verlichten van industriële ruimten of magazijnen. PHB2 is voorzien van een IP65 behuizing met geïntegreerde ventilatiesleuven voor een optimale koelin en uitgerust met performante SMD3030 leds en een dimbare 1-10V kwaliteitsdriver met lange levensduur. PHB2 is standaard voorzien van een mat polycarbonaat cover. Toestelrendement tot 130lm/W bij 4000K, standaard lichtbundel van 110°. Met de optionele muurbeugel is het mogelijk om het toestel in een vaste positie te monteren op wand of plafond. Mogelijke opties : dimbaar DALI, muurbeugel, valbeveiliging, transparante 60 of 90° lens.

														
IP65	IK08	110	5	tot 130	0,99	70.000 L80B10	JA	>80	4000	DALI	EMC3030	33	JA	NEE

Technische eigenschappen

Referentie	PHB21004DA
EAN code	5420076284114
ETIM code	EC001716

Elektrische eigenschappen

Systeem vermogen (W)	100,92
LED vermogen (W)	99,9
Aansluitspanning (Vac)	220-240
Frequentie (Hz)	47-63
Driver inbegrepen	ja
Driver intern/extern	intern
Driver merk	Inventronics
Driver type	
Dimbaar	DALI
Flicker free	ja
Power factor	0,99
THD	<15%
Driver output (V)	
Driver output (mA)	
Isolatieklasse	I
Energie klasse	E
Aantal op 16A B curve	
Aantal op 16A C curve	7
Aantal op 16A D curve	12
Inrush current driver	62A

Garantie en certificatie

ENEC	ja
Garantie (jaar)	5 (exclusief batterijen)

Lichttechnische eigenschappen

Lichtbundel(°)	110
Kleurtemperatuur (K)	4000
Kleurweergave CRI	>80
UGR	33
Kleurvastheid SDCM	<5
Lumen output (Lm)	13365
Lm/W	130
Flux code	
Ledchip	EMC3030
Ledfabrikant	Tiandian
Aantal LEDs	168
Fotobiologische klasse	RG1

Afmeting en materiaal eigenschappen

Afmetingen (LxBxH)	250x250x136mm
Gewicht (kg)	2,8
Kleur	zwart
Werktemperatuur (°C)	-30~+45
IP waarde	IP65
IK waarde	IK08
UV bestendig	ja
Zeewater bestendig	nee
UL 94	
Aantal in bulk	1
Aantal op pallet	84
Minimum bestelaantal	1
Stockartikel	nee

PHB21004DA - Ledklok PHB2 100W 4000K IP65 DALI

Lumen distribution

LUMINOUS INTENSITY DISTRIBUTION DIAGRAM

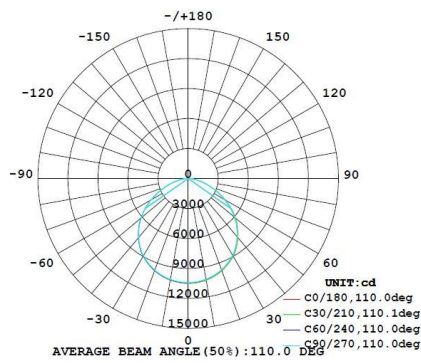

Spectrum distribution

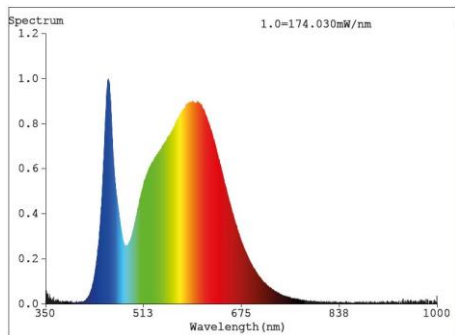



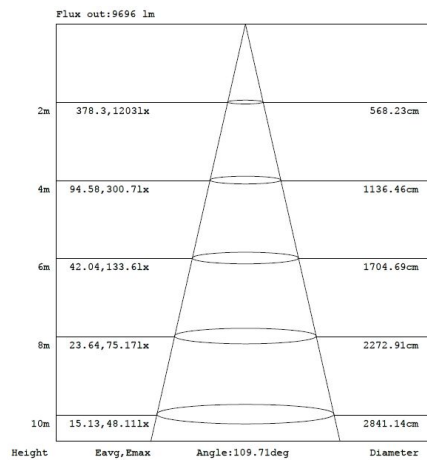

Distance curve:

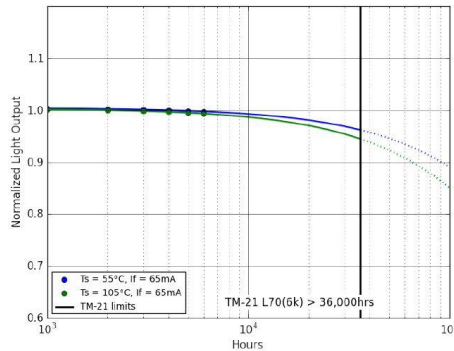

Lumendrop



Accessoires

PHB2150-PCC	Reflector prisma 100gr PHB2 75/100/150W	
PHB2150-COV	Afschermkap prisma reflector PHB2 75/100/150W	
PHB-WBR	Bevestigingsbeugel voor PHB/PHBP	
IP68-connect	Verbindingsset 3-polig IP68 2,5mm ² male-female	

Afmetingen

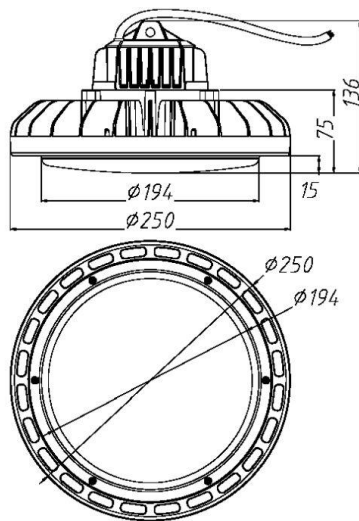

Aansluitschema



Isolation test 3,75KVac
TUV, GS, CB, D Mark, C