















F230DI-B4000 - Tracklight F2 30W 36° 4000K CRI90 intrack zwart



Richtbare railspot in een extra smalle behuizing voor universele Eutrack 3-fase rail. Behuizing zwart RAL9004 uitgerust met Citizen ledchip met hoge kleurweergave CRI90. Powergear railadapter met geïntegreerde flicker free Osram driver, niet dimbaar. Levensduur 50.000u L80B20, garantie 5 jaar.

														
IP20	IK07	36	5	tot 95	0,95	50.000 L80B20	JA	90	4000	NEE	COB1206	<19	NEE	JA

Technische eigenschappen

Referentie	F230DI-B4000
EAN code	5420076265298
ETIM code	EC001744

Elektrische eigenschappen

Systeem vermogen (W)	33,6
LED vermogen (W)	30
Aansluitspanning (Vac)	220-240V
Frequentie (Hz)	50/60
Driver inbegrepen	ja
Driver intern/extern	intern
Driver merk	Osram
Driver type	Powergear adapter
Dimbaar	nee
Flicker free	ja
Power factor	0,95
Aansluitkabel	no
Driver output (V)	42V
Driver output (mA)	800mA
Isolatieklasse	I
Energie klasse	A+
Aantal op 16A C curve	15
Aantal op 16A D curve	
Inrush current driver	<42A

Garantie en certificatie

ENEC	nee
Garantie (jaar)	5 (exclusief batterijen)
TM-21	Lifetime
L80B20	50.000
	Temp Tc
	50°C

Lichttechnische eigenschappen

Lichtbundel(°)	36
Kleurtemperatuur (K)	4000
Kleurweergave CRI	90
UGR	<19
Kleurvastheid SDCM	3
Lumen output (Lm)	3000
Lm/W	95
Flux code	
Ledchip	COB1206

Ledfabrikant	Citizen
Aantal LEDs	1
Fotobiologische klasse	RG0

Afmeting en materiaal eigenschappen

Afmetingen (LxBxH)	224x95x115mm
Gewicht (kg)	0,72
Kleur	zwart RAL9005
Werktemperatuur (°C)	-20~+45
IP waarde	IP20
IK waarde	IK07
UV bestendig	ja
Zeewater bestendig	nee
UL 94	
Aantal in bulk	18
Aantal op pallet	0
Minimum bestelaantal	1
Stockartikel	ja

F230DI-B4000 - Tracklight F2 30W 36° 4000K CRI90 intrack zwart

Lumen distribution

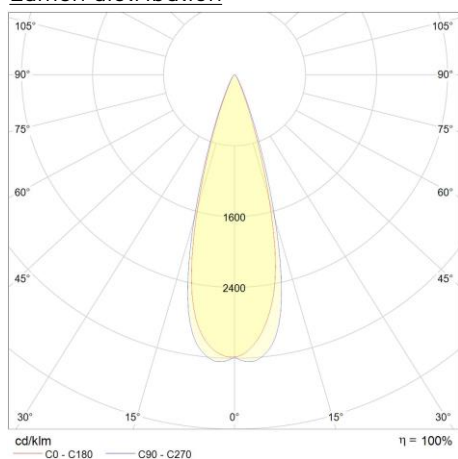

Distance curve:

Spectrum distribution

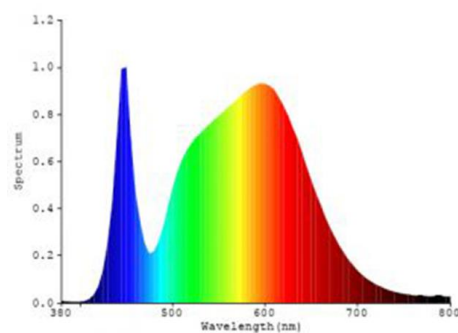

Lumendrop

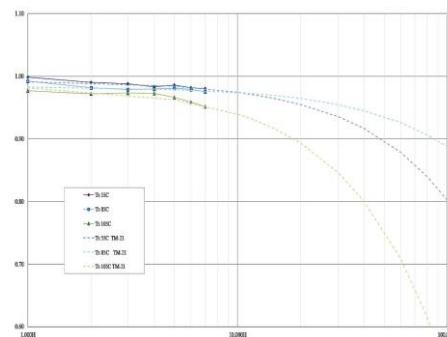

Afmetingen

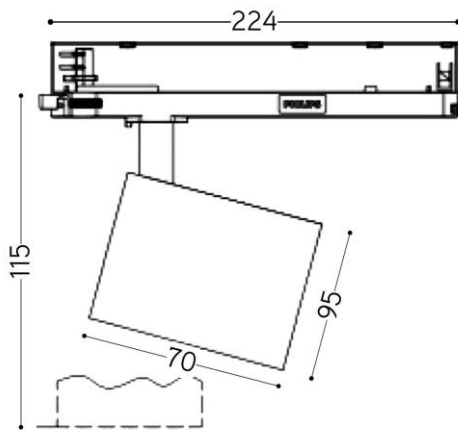

Aansluitschema

