

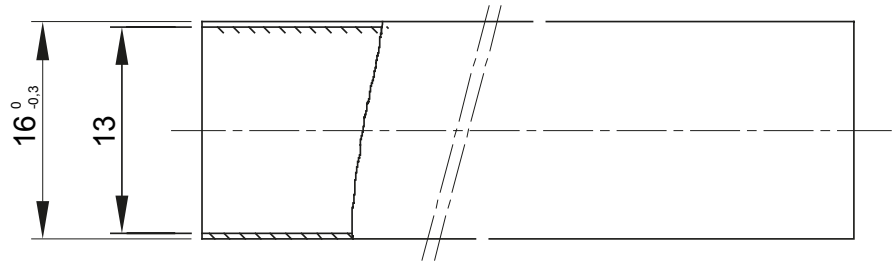

Light rigid conduits RK9 range, made of PVC, classification 22211, available in six diameters, from 16 to 50 mm, 3-metre long in gray RAL 7035 or white RAL 9010. Also available in five diameters from 16 to 40 mm, 2-meter long with sleeved end in gray RAL 7035. Suitable for electrical and/or data transmission systems. They can be integrated with pliable conduits, spiralled sheaths and junction boxes. Completing the offer, a wide range of accessories and routing components from IP40 to IP67 degree of protection. The RK9 conduits comply with standard EN 61386-1 and EN 61386-21.

Colour	Grey RAL 7035	Material	PVC
Length (m)	2	Conduits Ø (mm)	20
Glow Wire Test	960 °C	Resistance to compression	2 (Light - 320 N)
Resistance to impact	2 (Light - 320 N)	Resistance to bending	1 (Rigid)
Electrical characteristics	2 (With electrical insulating characteristics)	Protection against ingress of solid objects without accessories	0
Protection against ingress of water objects without accessories	0	Resistance against corrosion	Not applicable to plastic conduit systems
Fire resistance	1 (Non-flame propagating)	Protection against ingress of solid objects with accessories	4/6 (It depends on the accessories used)
Protection against ingress of water with accessories	0/5/7 (It depends on the accessories used)	Standard	EN 61386-1 EN 61386-22
Classification	22211		

DIMENSIONAL

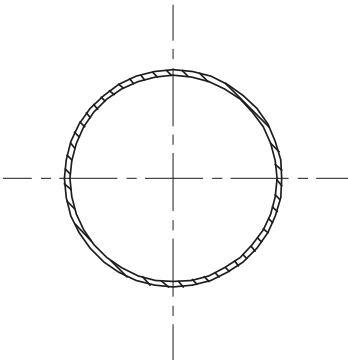

TECHNICAL SYMBOLOGY



STANDARDS/APPROVALS

