



Technische fiche PVT20000/IRC



Merk	EREA
Artikel nummer	PVT20000/IRC
EAN-code Barcode	5414503118509
Code	11850
Producttype	Driefasen transformator - Lage inschakelstroom
Spanning primair	3x 230V Δ -- 3x 400V Y+N
Spanning Secundair	3x 400V Y+N
Vermogen	20 000 VA
Normen	EN 61558-2-4

Algemene eigenschappen

Toepassing	Voor PV installaties	Max omgevings-temperatuur ta	40 °C
Beschermingsklasse	Voorbereid voor beschermingsklasse I	Temperatuurklasse van de trafo	B
IP graad	IP00	Afwerking	Onder vacuüm en onder druk geïmpregneerd

Elektrische eigenschappen

Frequentie	50-60 Hz	Rendement	97,3 %
Po	60 W	Pcu	500 W
Diëlektrische vastheid	4500 Vac	Isolati weerstand	200 MΩ
Diëlektrische vastheid tov de massa	2500 Vac	Specifieke eigenschappen	Primair niet gekoppeld, secundair in ster
Spanningsval (dU%)	2,5 %	Kortsluitspanning (Ucc %)	-
Aanbevolen zekering PRI	C50A (3x230V Δ) C32A (3x400V Y+N)	Aanbevolen zekering SEC	C32A (3x400V Y+N)

Mechanische eigenschappen

Aansluiting primair	Schroefklemmen 10 mm ²
Aansluiting secundair	Schroefklemmen 10 mm ²
Bevestiging	L-profielen met bevestigingsgaten

Beschermkap

Behuizing IP20	K20PVT/020
Behuizing IP23	K23PVT/020
Behuizing IP44	K44EI400/030

Afmetingen/gewicht

Afmetingen AxBxC	480x400x415 mm
Afmeting D	320 mm
Afmeting E	240 mm
Afmeting Φ	11 mm
Gewicht	185 kg

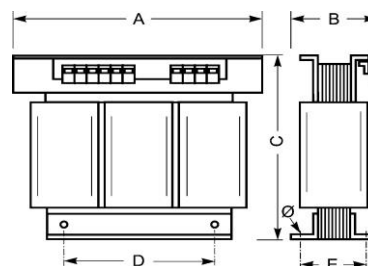



Aansluitschema PVT20000/IRC

400V Y+N → 400V Y+N

230V Δ → 400V Y+N

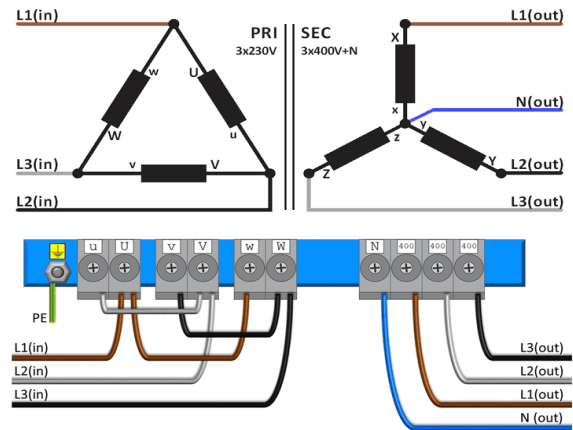
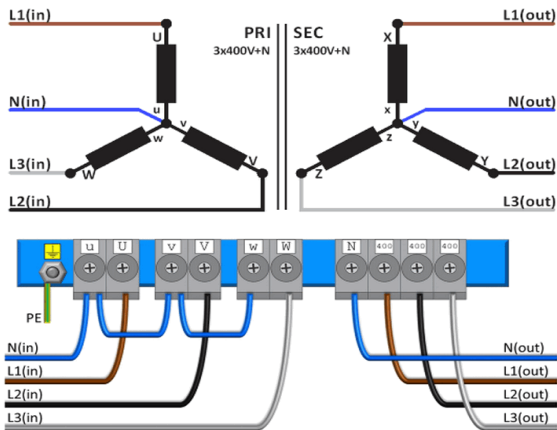



Accessoires PVT20000/IRC

IP20 beschermingskast

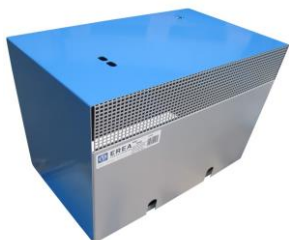

K20PVT/020

IP23 beschermingskast



K23PVT/020

Trillingsdemper

(4 stuks nodig per transfo)



Silent block 50

