

RAND 311 LED DIM8

DEEL
PARTIE
TEIL
PART
PARTE
PARTE **A**

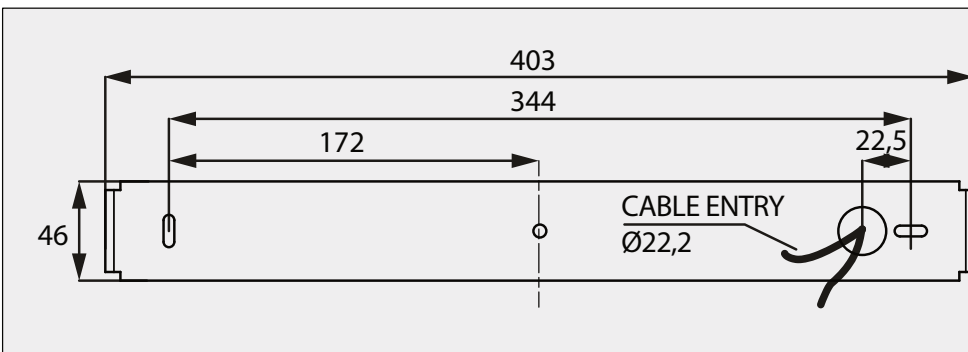

MAINS DIMMABLE	
I _o	3X 350mA
P _o	3X 13W
U _o	220-240V / 50-60Hz

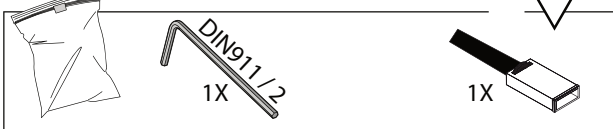
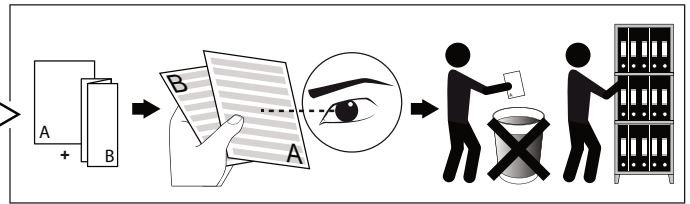
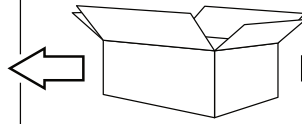
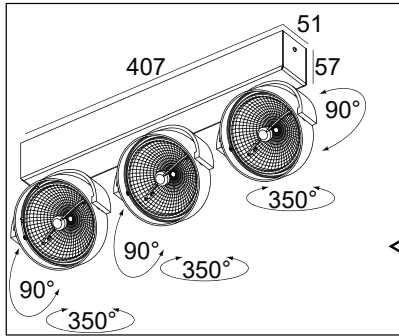

Leading Edge dimming



IP20

Beschermd tegen vaste voorwerpen die groter zijn dan 12 mm
 Protégé contre les objets solides de plus de 12 mm
 Geschützt gegen Festkörper größer als 12 mm
 Protected against solid objects greater than 12 mm
 Protegido contra objetos sólidos superiores a 12 mm
 Protetto contro oggetti solidi più grandi di 12 mm



Goederen zijn dubbel geïsoleerd - geen aarding nodig
 Les produits ont une isolation double et ne peuvent pas être mis à la terre
 Güter sind doppelt isoliert und müssen nicht geerdet werden
 Goods have double insulation and must not be grounded
 Los productos tienen u aislamiento doble y no se pueden conectar a tierra
 I prodotti possiedono un doppio isolamento e non devono essere collegati a terra

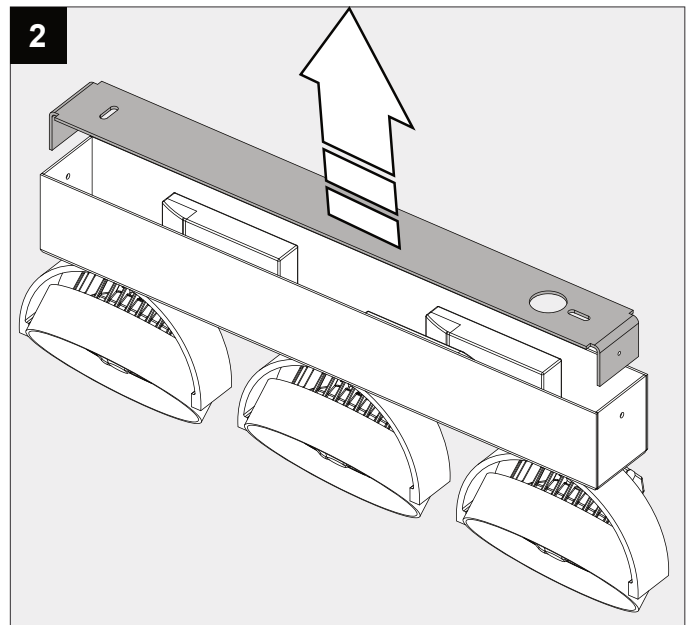
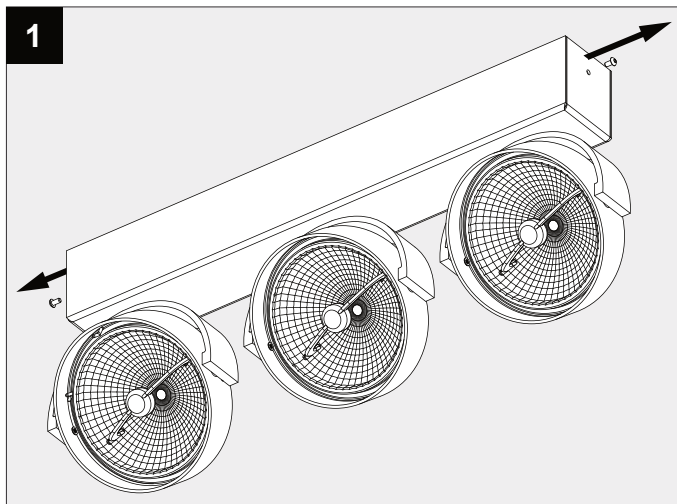

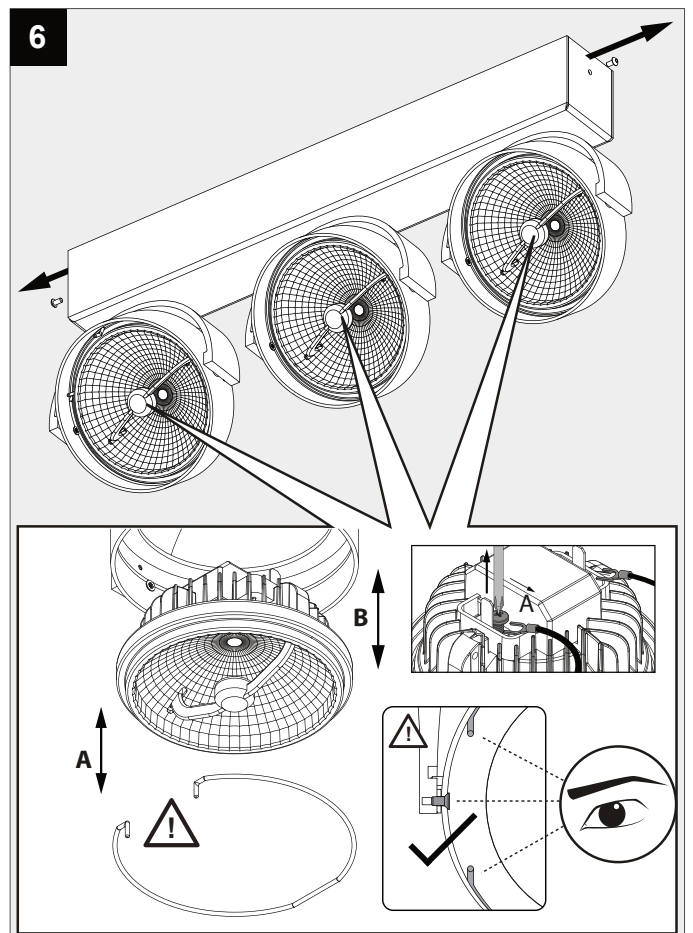
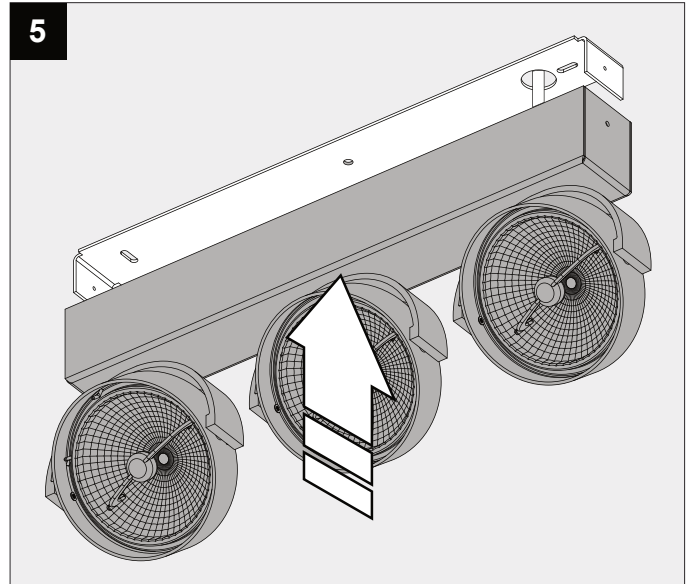
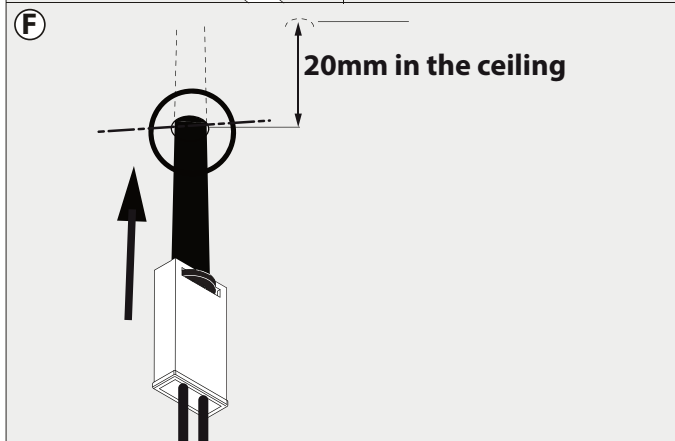
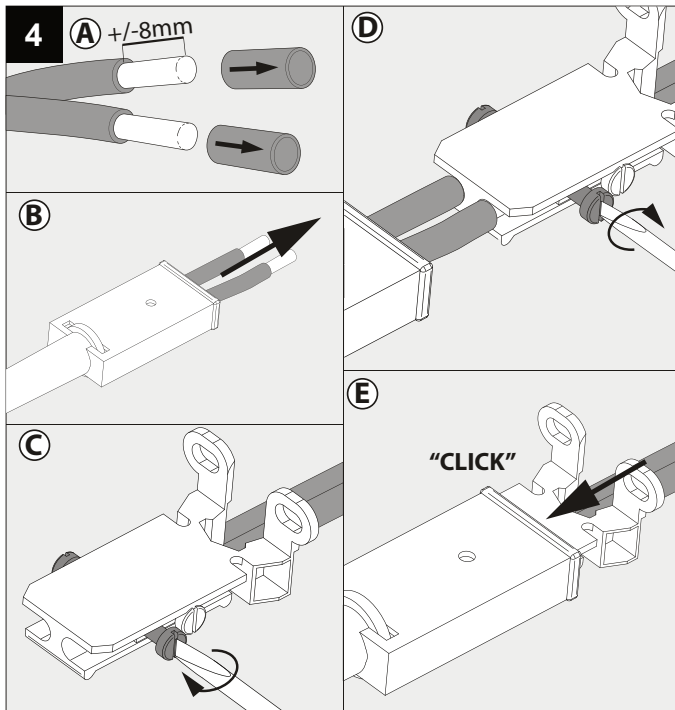
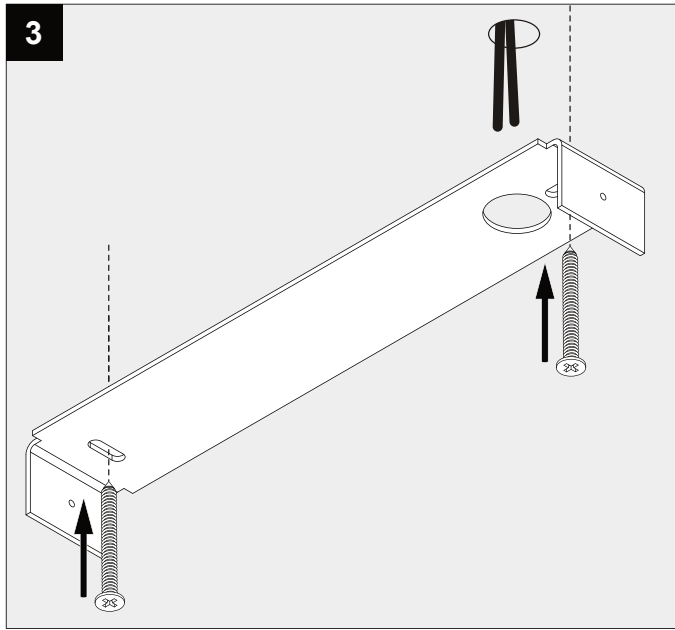

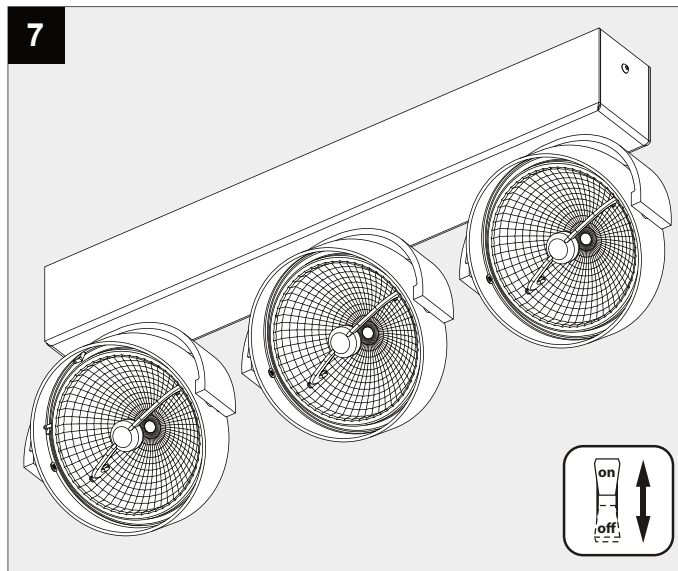

G This product contains a light source of energy efficiency class G
 本产品包含能效等级为 G 的光源
 Этот артикул содержит источник света с энергоэффективностью класса G
 يحتوي هذا المنتج على مصدر ضوء ذو كفاءة الطاقة G
 Dit product bevat een verlichtingsbron van energie-efficiëntieklasse G
 Ce produit contient une source d'éclairage de classe d'efficacité énergétique G
 Dieses Produkt enthält eine Lichtquelle der Energieeffizienzklasse G
 Este producto contiene una fuente de iluminación de clase de eficiencia energética G
 Questo prodotto contiene una fonte di illuminazione in classe di efficienza energetica G

Replaceable (LED only) light source and control gear by a professional
 (仅针对LED) 光源及其控制设备只能由专业人士更换
 (для СВЕТОДИОДНЫХ светильников) замена источника света и блока питания может быть произведена только квалифицированным специалистом
 مصدر الضوء (ليد فقط) و معدات التحكم قابليين للتغيير بإشراف الفني المتخصص

Verlichtingsbron (enkel LED) en voorschakelapparaat kan enkel vervangen worden door een professional
 La source d'éclairage (uniquement LED) et le ballast ne peut être remplacé que par un professionnel
 Die Lichtquelle (nur LED) und Vorschaltgerät kann nur von einem Fachmann ausgetauscht werden
 La fuente de iluminación (solo LED) solo puede ser reemplazada por un profesional
 La sorgente luminosa (LED) e l'alimentatore possono essere sostituiti solo da un professionista.