

DEEP RINGO TRIMLESS LED IP

DEEL
PARTIE
TEIL
PART
PARTE
PARTE **A**

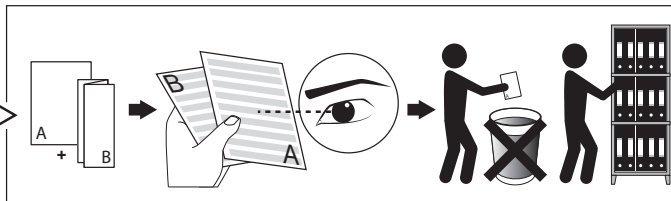

MOUNTING KIT R82 TRIMLESS OFA IN CONCRETE

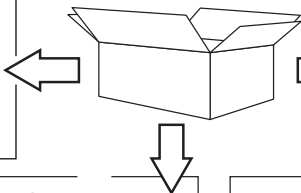
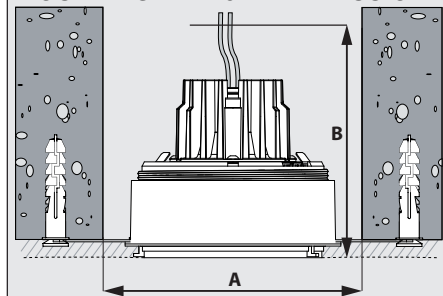

	mm
A	KIT
B	95

REQUIRED

MOUNTING KIT R82 TRIMLESS O.F.A.

202 11 82 O.F.A.

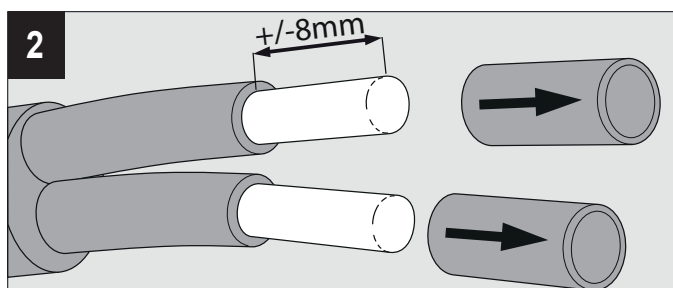
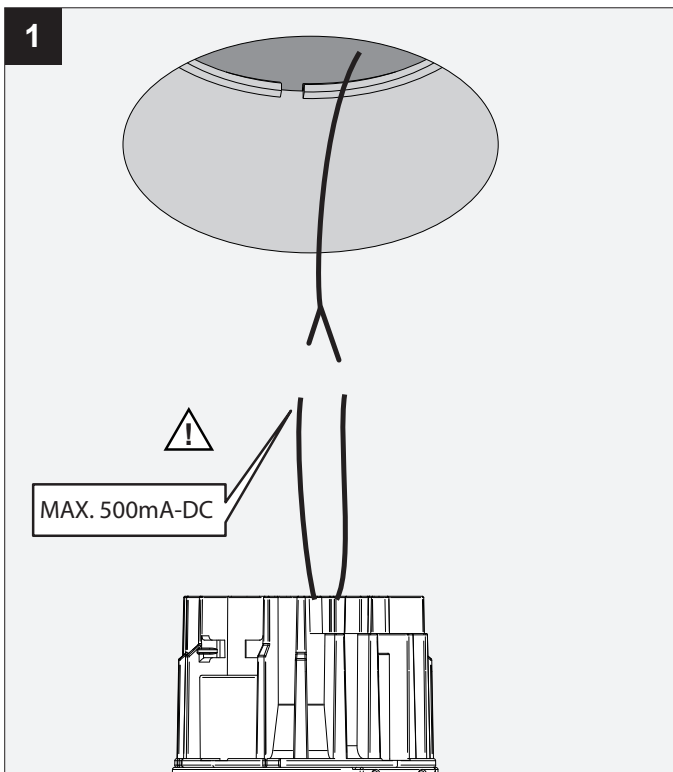

ELECTRICAL CONNECTION

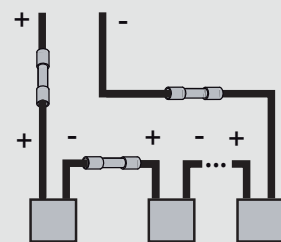
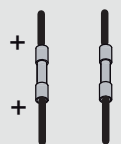

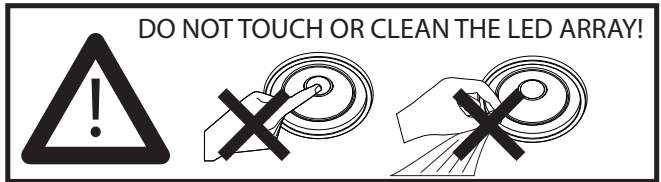
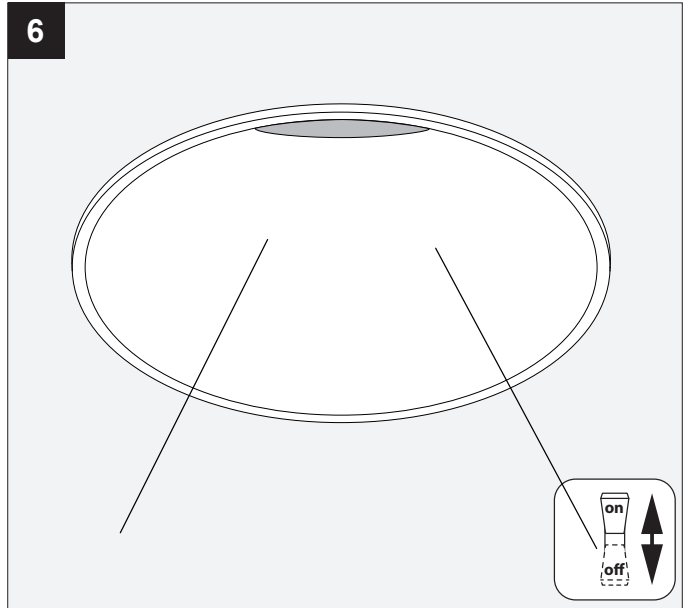
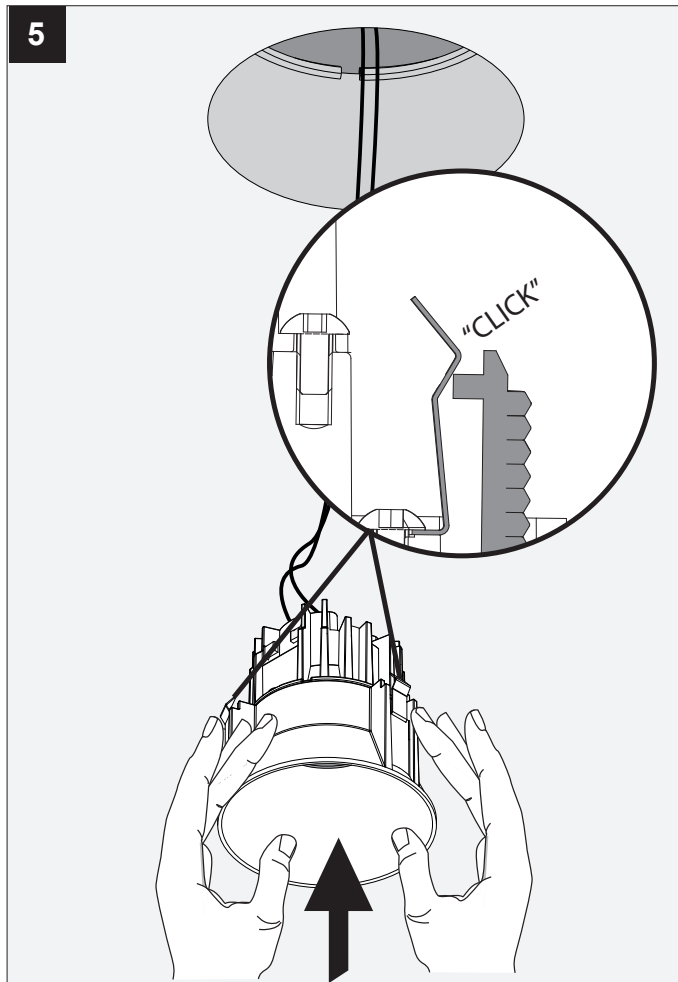
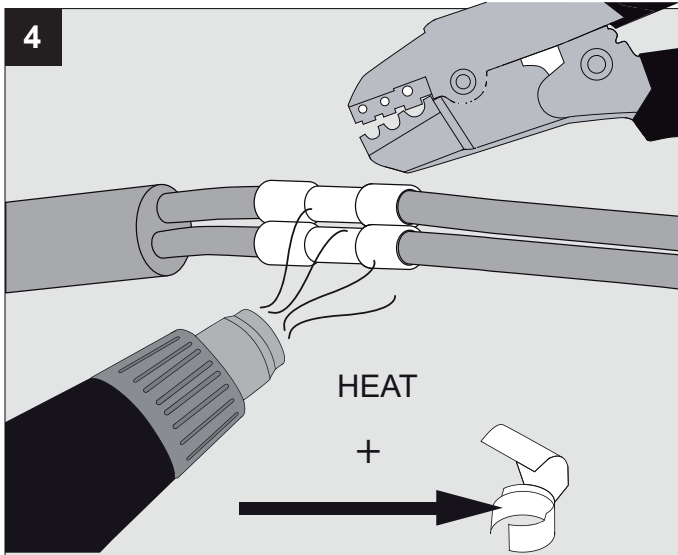
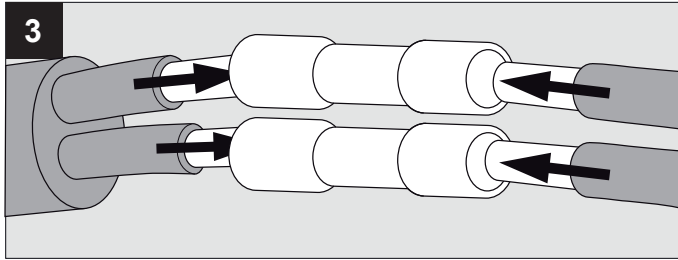

- Use only power supplies that are certified according to the applicable IEC or UL safety standards.
- Use only SELV power supplies.
- Check the ratings of the power supply with those of the luminaire. The maximum current rating must be taken into account.
- The indicated typical voltage must not be used to select a constant voltage power supply but is intended to select a constant current power supply that is able to cover that typical voltage.
- Take appropriate ESD measures. Avoid touching bare conductors.
- Leds or led luminaires that require a current controlled power supply must never be connected in parallel.
- Leds can be damaged by the contact with certain chemicals or chemical gasses.
- Therefore led domes or led engines should never be cleaned with chemical substances.
- The following substances have proven to have a negative influence on the performance and must not be used in the direct environment of a led luminaire.
 - Methyl acetate or ethyl acetate (i.e., nail polish remover)
 - Cyanoacrylates (i.e., "Superglue")
 - Glycol ethers (including Radio Shack® Precision Electronics Cleaner - dipropylene glycol monomethyl ether)
 - Formaldehyde or butadiene (including Ashland PLIOBOND® adhesive)
 - Dymax 984-LVUF conformal coating
 - Loctite Sumo Glue
 - Gorilla Glue
 - Bleach, Bleach-containing cleaners, sprays
 - Loctite 384 adhesive
 - Loctite 7387 activator
 - Loctite 242 threadlocker
- Remove insulation and/or provide sufficient ventilation so that the indicated max Tc is not surpassed.
- Leds are susceptible to switching transients. Therefore switching must be done in the primary circuit of the power supply.
- DELTA LIGHT recommends to use the power supplies that are indicated in the Lighting Bible.
- Respect polarity
- Don't test LED luminaires one by one on a powersupply that is switched on.

De verlichtingsbron van dit verlichtingstoestel zal enkel door de fabrikant of door de fabrikant aangestelde installateur vervangen worden.

La source lumière de cet appareil ne sera remplacée que par l'entreprise ou par un agent reconnu.

Das enthaltene Leuchtmittel sollte nur durch entsprechendes Fachpersonal ersetzt werden.

The light source contained in this luminaire shall only be replaced by the manufacturer or his service agent.

La fuente de iluminación que tiene esta luminaria sólo puede remplazarse por el fabricante o por un instalador autorizado.

La sorgente luminosa incorporata in questo apparecchio può essere sostituita solo dal produttore, da un suo centro assistenza oppure da una persona in possesso della necessaria abilitazione.

Replaceable (LED only) light source by a professional
 可由专业人士更换 (仅限于LED) 光源
 Сменный (только светодиодный) источник света только квалифицированным персоналом

 Verlichtingsbron (enkel LED) kan enkel vervangen worden door een professional
 La source d'éclairage (uniquement LED) ne peut être remplacée que par un professionnel
 Die Lichtquelle (nur LED) kann nur von einem Fachmann ausgetauscht werden
 La fuente de iluminación (solo LED) y equipo de control solo puede ser reemplazada por un profesional
 La fonte di illuminazione (solo LED) può essere sostituita solo da un professionista

This product contains a light source of energy efficiency class E
 本产品包含能效等级为 E 的光源
 Этот артикул содержит источник света с энергоэффективностью класса E
 يحتوي هذا المنتج على مصدر ضوء ذو كفاءة الطاقة E

 Dit product bevat een verlichtingsbron van energie-efficiëntieklasse E
 Ce produit contient une source d'éclairage de classe d'efficacité énergétique E
 Dieses Produkt enthält eine Lichtquelle der Energieeffizienzklasse E
 Este producto contiene una fuente de iluminación de clase de eficiencia energética E
 Questo prodotto contiene una fonte di illuminazione in classe di efficienza energetica E

 Beschermd tegen vaste voorwerpen die groter zijn dan 12 mm
 Protégé contre les objets solides de plus de 12 mm
 Geschützt gegen Festkörper größer als 12 mm
 Protected against solid objects greater than 12 mm
 Protegido contra objetos sólidos superiores a 12 mm
 Protetto contro oggetti solidi più grandi di 12 mm

IP20

 Beschermd tegen vaste voorwerpen die groter zijn dan 1,0 mm - Beschermd tegen opspattend water
 Protégé contre les objets solides de plus de 1,0 mm - Protégé contre les projections d'eau
 Geschützt gegen Festkörper größer als 1,0 mm - Geschützt gegen Spritzwasser
 Protected against solid objects greater than 1,0 mm - Protected against splashing water
 Protegido contra objetos sólidos superiores a 1,0 mm - Protegido contra salpicaduras de agua
 Protetto contro oggetti solidi più grandi di 1,0 mm - protetto contro gli schizzi d'acqua

IP44

 Enkel geschikt voor toestellen op zeer lage spanning (minder dan 50 V AC)
 Convient uniquement pour les produits à très basse tension (moins de 50 V AC)
 Geeignet für Güter mit sehr niedriger Spannung (unter 50 V AC)
 Only suited for goods at very low voltage (below 50 V AC)
 Se recomienda únicamente para aquellos productos de tensión muy baja (menos de 50 V AC)
 Vale unicamente per i prodotti a tensione molto bassa (inferiore a 50 V AC)

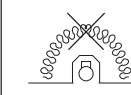
 Toestel niet geschikt om te worden afgedekt met thermische isolatie.
 Luminaires non appropriées pour recouvrement d'un matériau isolant thermique.
 Das Gerät/Die Leuchte darf nicht abgedeckt werden mit thermischer Isolation.
 Luminare not suitable for covering with insulating material.
 Luminaria no apta para cubrir con material aislante.
 Apparecchio non adatto per essere coperto da materiale isolante.