

SE NH1 (785 643)

- For indoor installations
- Protection against reconnection
- With "Nicht schalten" symbol [Do not close the circuit] acc. to national regulations (VBG 125)
- Insulating blade for NH fuse holders and distribution blocks



Figure without obligation

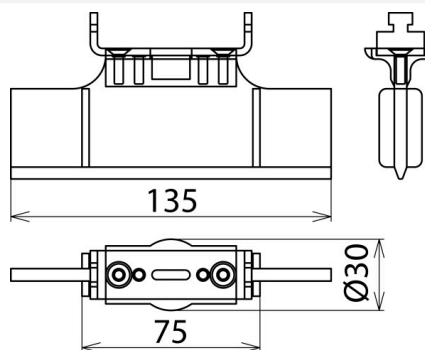

Figure without obligation

Type	SE NH1
Part No.	785 643
Nominal voltage (U _N)	Up to 1000 V
Size	1
Blade	38 x 5 mm
Dimensions	135 mm
Standard	VBG 125 and DIN 40008
Use	For indoor installations
Weight	80 g
Customs tariff number (Comb. Nomenclature EU)	39269097
GTIN	4013364087910
PU	10 pc(s)

We reserve the right to introduce changes in performance, configuration and technology, dimensions, weights and materials in the course of technical progress. The figures are shown without obligation.