

UK K25 FL30 HG (774 251)

- Universal clamp with plastic handle
- For flat and round conductors up to 30 mm and fixed ball points, ball Ø25 mm



Figure without obligation

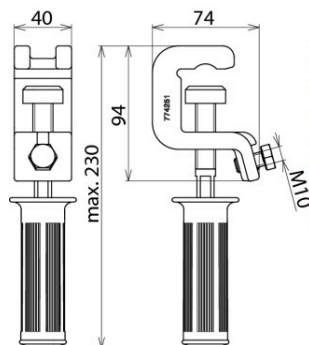

Figure without obligation

*) Klemmbereich und Seilquerschnitt für Uniklemmen am:			
Kugelfestpunkt Ø	T-Anschluss Halsweite	Rd / Fl Klemmbereich	Seilquerschnitt
20/25/30 mm	15/18 mm	20/30 mm	16 mm ²
20/25/30 mm	15/18 mm	20/30 mm	25 mm ²
20/25/30 mm	15/18 mm	20/30 mm	35 mm ²
20/25/30 mm	15/18 mm	20/30 mm	50 mm ²
20/25/30 mm	15/18 mm	20/30 mm	70 mm ²
20/25/30 mm	15/18 mm	-	95 mm ²
-/25/30 mm	-	-	120 mm ²
-	-	-	150 mm ²

Type	UK K25 FL30 HG
Part No.	774 251
For fixed ball point Ø	25 / 30 mm
Anti-rotation cable lug	PK2 (Ø10.5 mm)
For cable cross section Cu	50 mm ²
Max. short-circuit current I _k 0.06 s	34.0 kA
DB drawing No.	4 Ebgw 01.64
DB material No.	157 537
Material (pressure plate)	St/gal Zn
Material (clamp body)	Copper alloy
Material (shaft)	Stainless steel
Weight	955 g
Customs tariff number (Comb. Nomenclature EU)	85389099
GTIN	4013364006003
PU	1 pc(s)

We reserve the right to introduce changes in performance, configuration and technology, dimensions, weights and materials in the course of technical progress. The figures are shown without obligation.