

UEK 25 FS (774 034)

- Earthing and short-circuiting devices can be configured online via the earthing and short-circuiting configurator



Figure without obligation

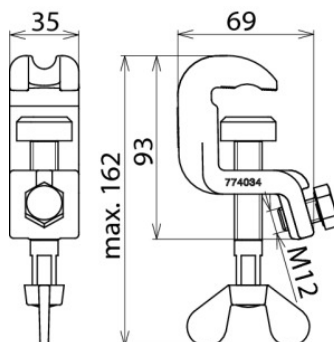

Figure without obligation

*) Clamping range and maximum cable cross-section of universal clamps used for:

Fixed ball point Ø	Phase T pin collar width	Rd / FI clamping range	Cable cross-section
20/25/30 mm	15/18 mm	20/30 mm	16 mm ²
20/25/30 mm	15/18 mm	20/30 mm	25 mm ²
20/25/30 mm	15/18 mm	20/30 mm	35 mm ²
20/25/30 mm	15/18 mm	20/30 mm	50 mm ²
20/25/30 mm	15/18 mm	20/30 mm	70 mm ²
20/25/30 mm	15/18 mm	-	95 mm ²
-/25/30 mm	-	-	120 mm ²
-	-	-	150 mm ²

Type	UEK 25 FS
Part No.	774 034
For fixed ball point Ø	20 / 25 mm
For T pins with a collar width of	15 mm
Rd / FI clamping range	20 mm
Anti-rotation cable lug	PK1
For cable cross-section Cu	16 ... 120 ¹⁾ mm ²
Max. short-circuit current I _k 0.5 s	33.5 kA
Max. short-circuit current I _k 1 s	23.7 kA
Standard	EN/IEC 61230 (DIN VDE 0683-100)
Temperature range	-25 °C ... +55 °C
Material (clamp body)	Copper alloy/gal Sn
Material (shaft)	Copper alloy/gal Sn
Material (pressure plate)	St/gal Zn
Weight	662 g
Customs tariff number (Comb. Nomenclature EU)	85389099
GTIN	4013364114586
PU	1 pc(s)

¹⁾ See table for „Clamping range and maximum cable cross-section of universal clamps used for“

We reserve the right to introduce changes in performance, configuration and technology, dimensions, weights and materials in the course of technical progress. The figures are shown without obligation.

The clamps must have the same maximum short-circuit current as the earthing and short-circuiting cables!